



INSTALLATION GUIDE

SQUARE BALUSTERS

26" - 32" - 36"

17226-27-32-33-36-37



Got a question? - Contact us:

First contact our friendly customer service team for assistance.

Email: info@pylex.com or phone: 1-800-264-1881

Monday to Friday: 8:30 am to 4:30 pm (EST)

Replacement for damaged or missing parts will be shipped promptly.

Rev.: 62-0529

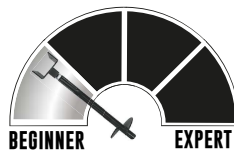

DECK AND FENCE HARDWARE

WWW.PYLEX.COM / 1 800-264-1881

NOTE: FOR STAIR RAILING, PRODUCT #17262 IS REQUIRED AND NOT INCLUDED.

MATERIALS and TOOLS REQUIRED

17226 - 17232 - 17236



Ø 1/16"

20 Connectors

TEMPLATE



10 Balusters



2" x 4"
Not included

17227 - 17233 - 17237



Ø 1/16"

60 Connectors

TEMPLATE



30 Balusters



2" x 4"
Not included

NUMBER OF BALUSTERS REQUIRED



DISTANCE		BALUSTERS
FROM	TO	
75- ³ / ₄ "	71- ¹ / ₂ "	16
71- ¹ / ₄ "	67"	15
66- ³ / ₄ "	62- ¹ / ₂ "	14
62- ¹ / ₄ "	58"	13
57- ³ / ₄ "	53- ¹ / ₂ "	12
53- ¹ / ₄ "	49"	11
48- ³ / ₄ "	44- ¹ / ₂ "	10
44- ¹ / ₄ "	40"	9

DISTANCE		BALUSTERS
FROM	TO	
39- ³ / ₄ "	35- ¹ / ₂ "	8
35- ¹ / ₄ "	31"	7
30- ³ / ₄ "	26- ¹ / ₂ "	6
26- ¹ / ₄ "	22"	5
21- ³ / ₄ "	17- ¹ / ₂ "	4
17- ¹ / ₄ "	13"	3
12- ³ / ₄ "	8- ¹ / ₂ "	2
8- ¹ / ₄ "	4"	1

STEP 1 - INSTALLATION ON THE RAILING



MEASURE THE DISTANCE
BETWEEN POSTS

see table
page 2

48"*
10 balusters

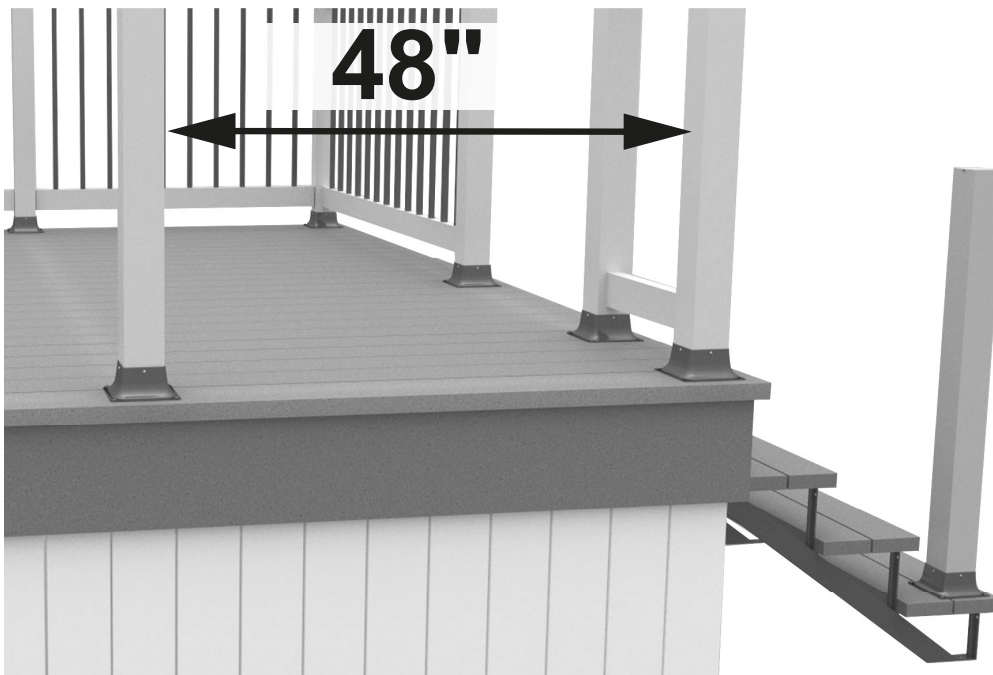

USE TWO 2" X 4" PIECES LONGER THAN
THE FINAL MEASUREMENT (55")*

4-1/2"
SPACE BETWEEN OF BALUSTERS

GABARIT
RAMPE



Pylex
.COM

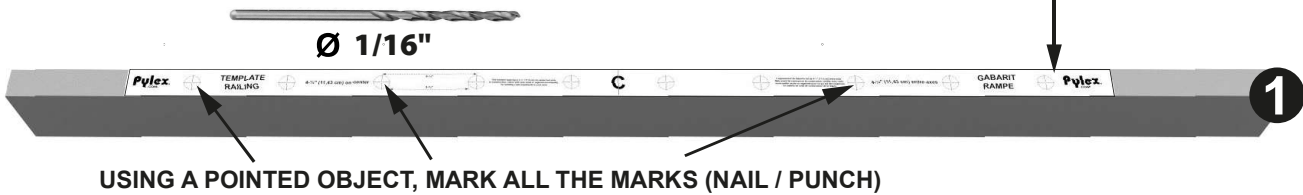

USING A POINTED OBJECT, MARK ALL THE MARKS (NAIL / PUNCH)

USE A SQUARE TO DRAW A
LINE ON THE TOP 2" X 4"

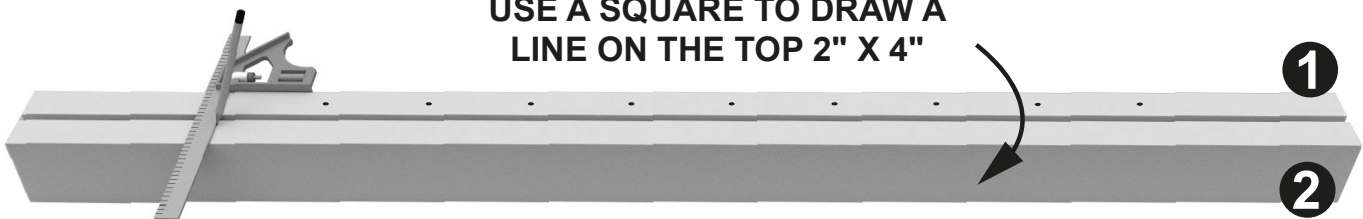

PRE-DRILL ALL MARKS ON THE
TOP 2" X 4"

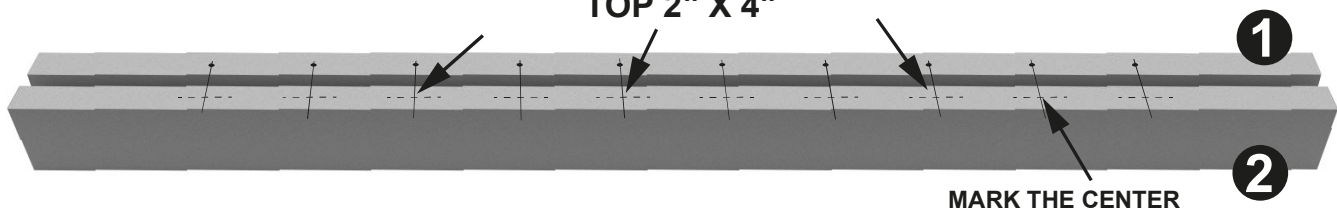

MARK THE CENTER

*USE YOUR MEASUREMENTS

STEP 2 - INSTALLATION ON THE RAILING



 No 2

SURFACE
CONNECTORS

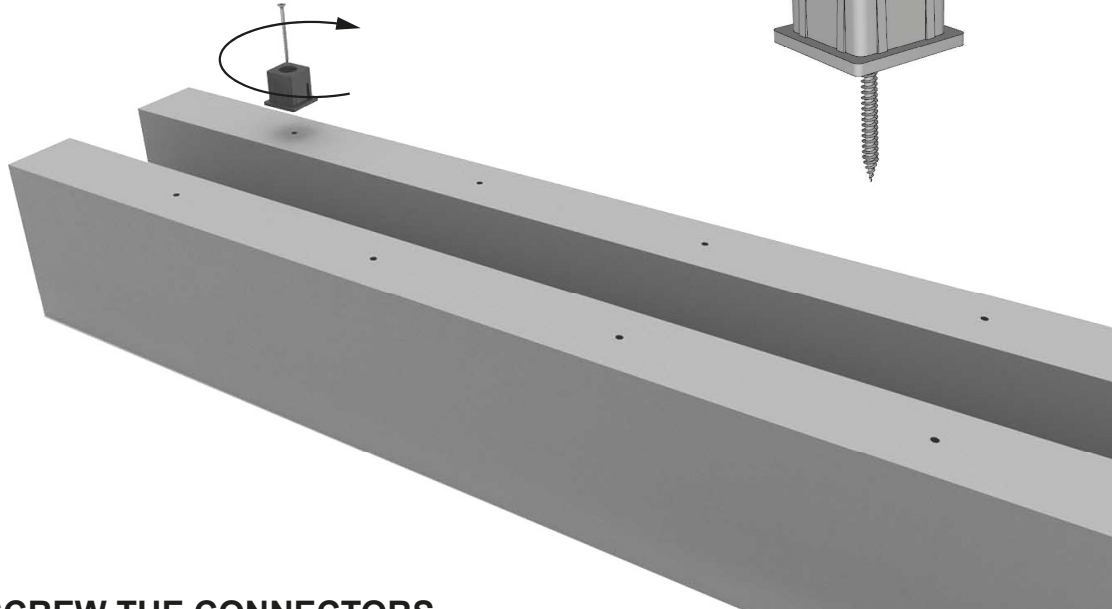
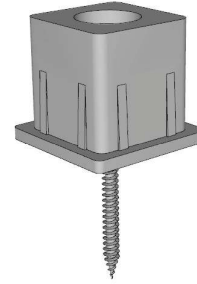

SCREW THE CONNECTORS
INTO THE PRE-DRILLED HOLES

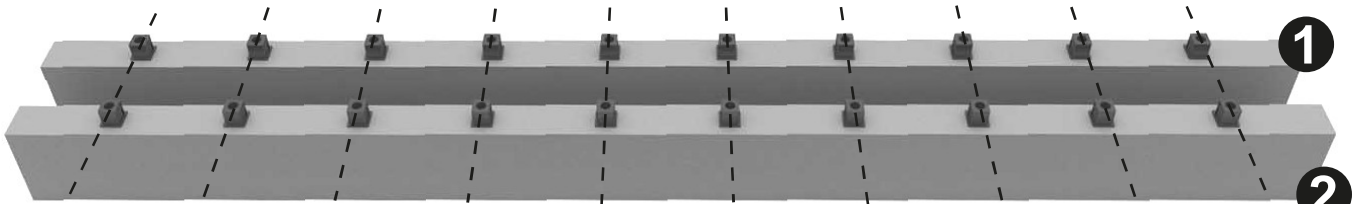

ENSURE THE SAME DISTANCE
ON EACH SIDE (E.G. : 3-3/4")

(This measurement may vary depending on the installation)

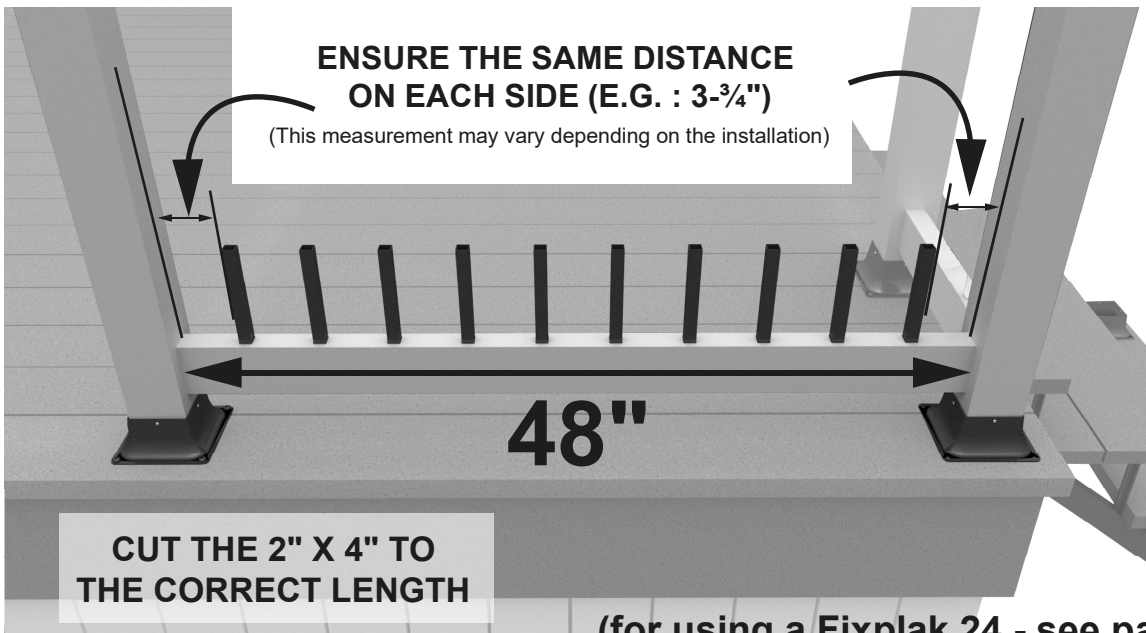

(for using a Fixplak 24 - see page 5)

STEP 3 - INSTALLATION ON THE RAILING



ASSEMBLE THE BALUSTERS AS SHOWN

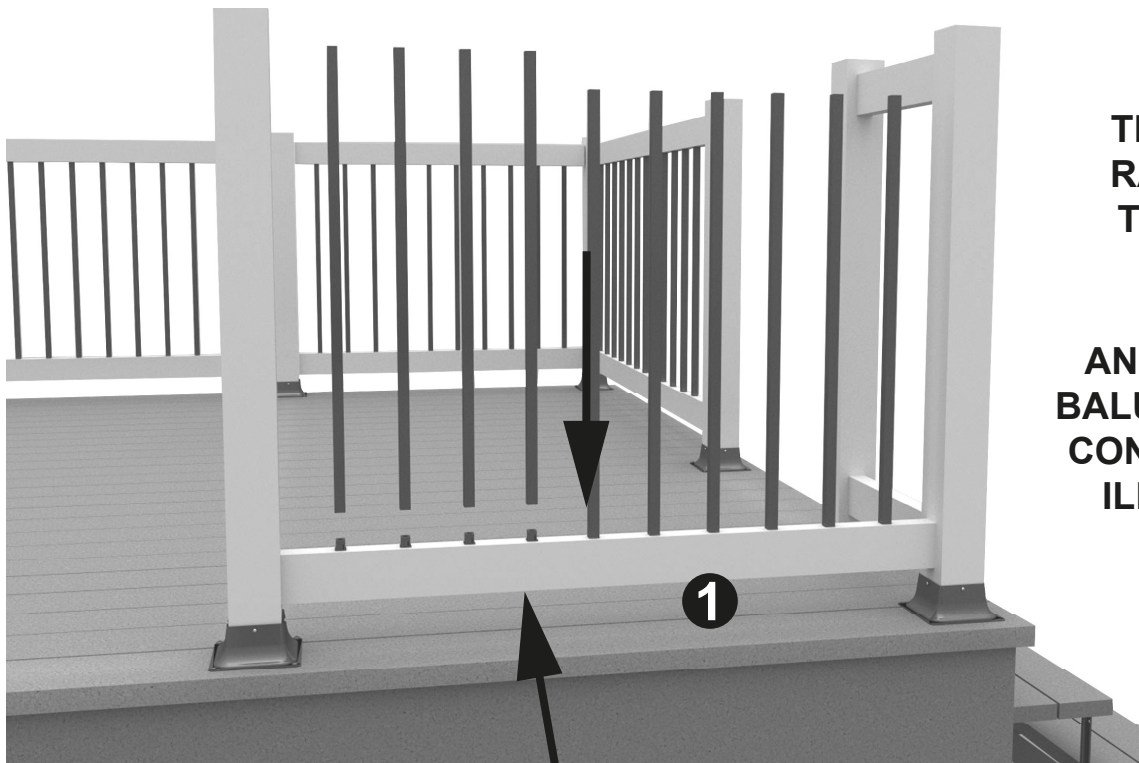

FIX THE LOWER RAILING TO THE POSTS

AND PLACE THE BALUSTERS IN THE CONNECTORS AS ILLUSTRATED.

FIX THE RAILING TO THE POSTS

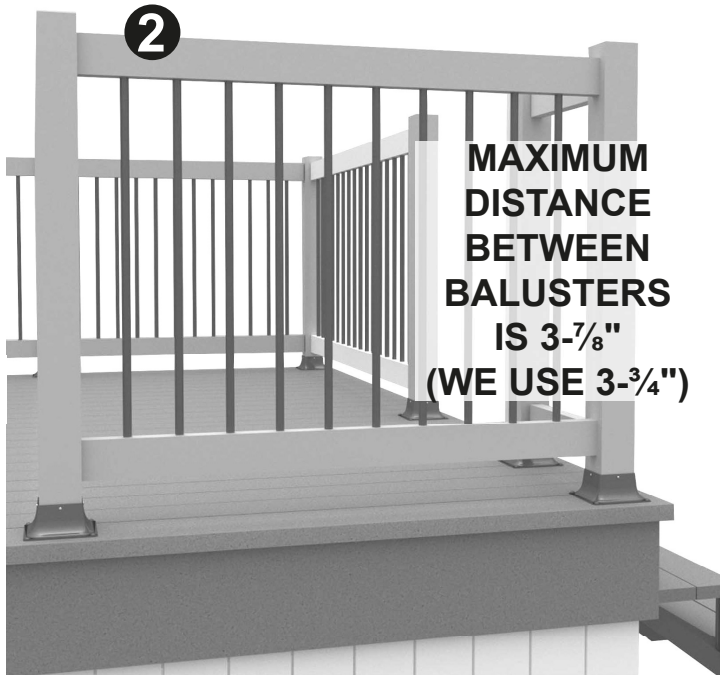

MAXIMUM DISTANCE BETWEEN BALUSTERS IS 3-7/8" (WE USE 3-3/4")

INSTALL THE UPPER RAILING INTO THE ALREADY INSTALLED BALUSTERS

USING A FIXPLAK 24 sold separately

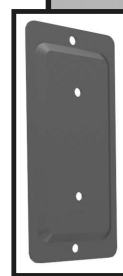

RAILING

REMOVE THE THICKNESS OF THE FIXPLAK ON THE RAILING

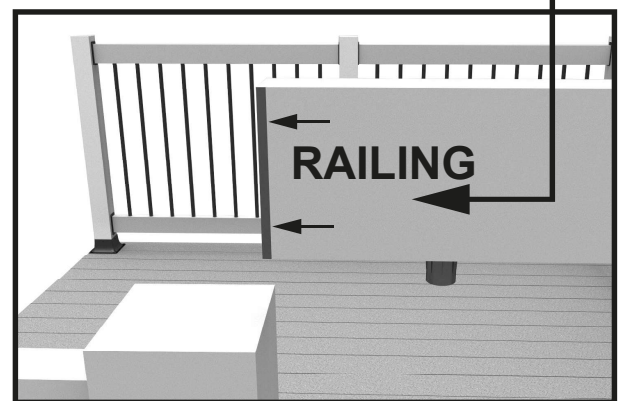

RAILING

STEP 4 - INSTALLATION ON STAIR RAILING

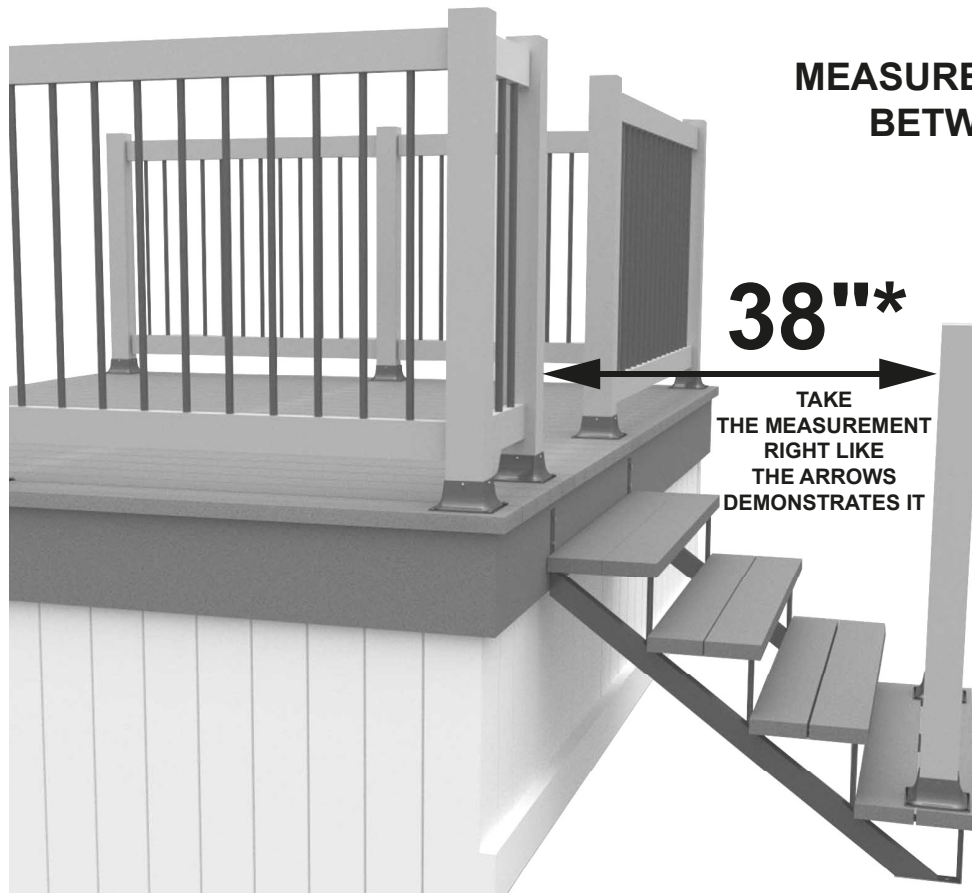

MEASURE THE DISTANCE BETWEEN POSTS

38"*

TAKE THE MEASUREMENT RIGHT LIKE THE ARROWS DEMONSTRATES IT

SEE THE TABLE PAGE 2
8 balusters

5-1/2"

SPACE BETWEEN OF BALUSTERS

USE TWO 2" X 4" LONGER THAN THE FINAL MEASUREMENT (60")*



TEMPLATE STAIR RAILING



USING A POINTED OBJECT, MARK ALL THE MARKS (NAIL / PUNCH)

USE A SQUARE TO DRAW A LINE ON THE TOP 2" X 4"

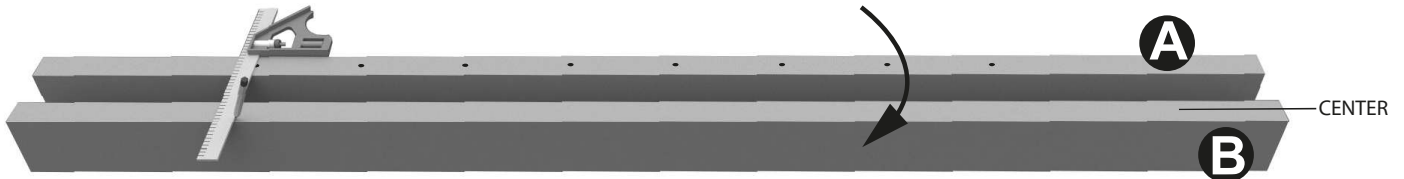

Ø 1/16"

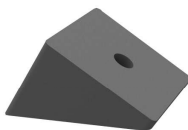

PRODUCT # 17262
NOT INCLUDED

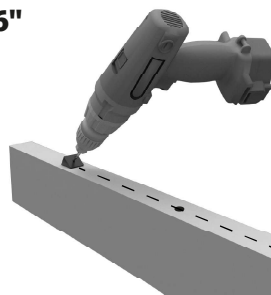

USING PRODUCT #17262 / PRE-DRILL ALL MARKS

PRODUCT #17162 SERVES AS YOUR GUIDE

MARK THE CENTER

STEP 5 - INSTALLATION ON STAIR RAILING

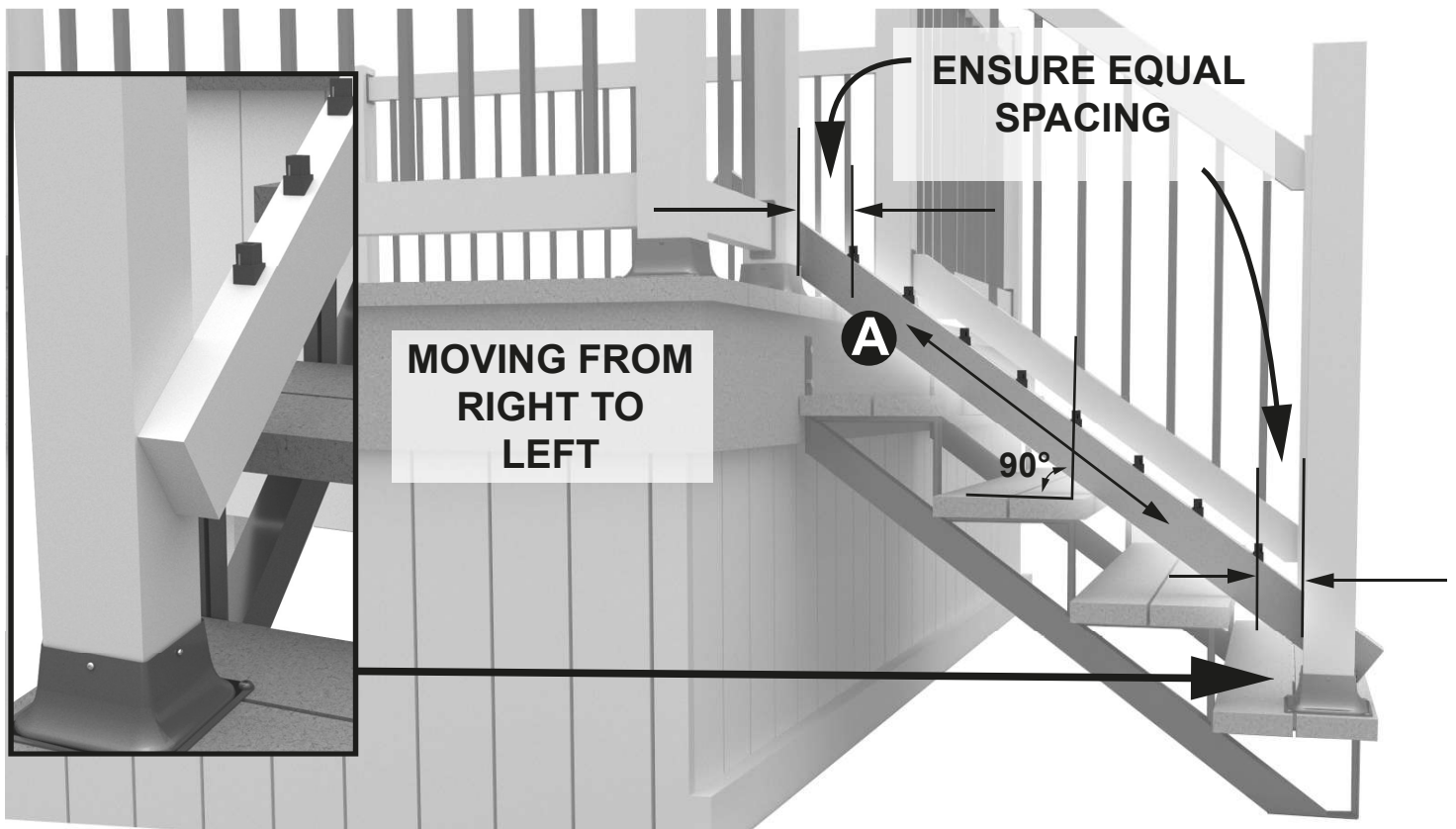
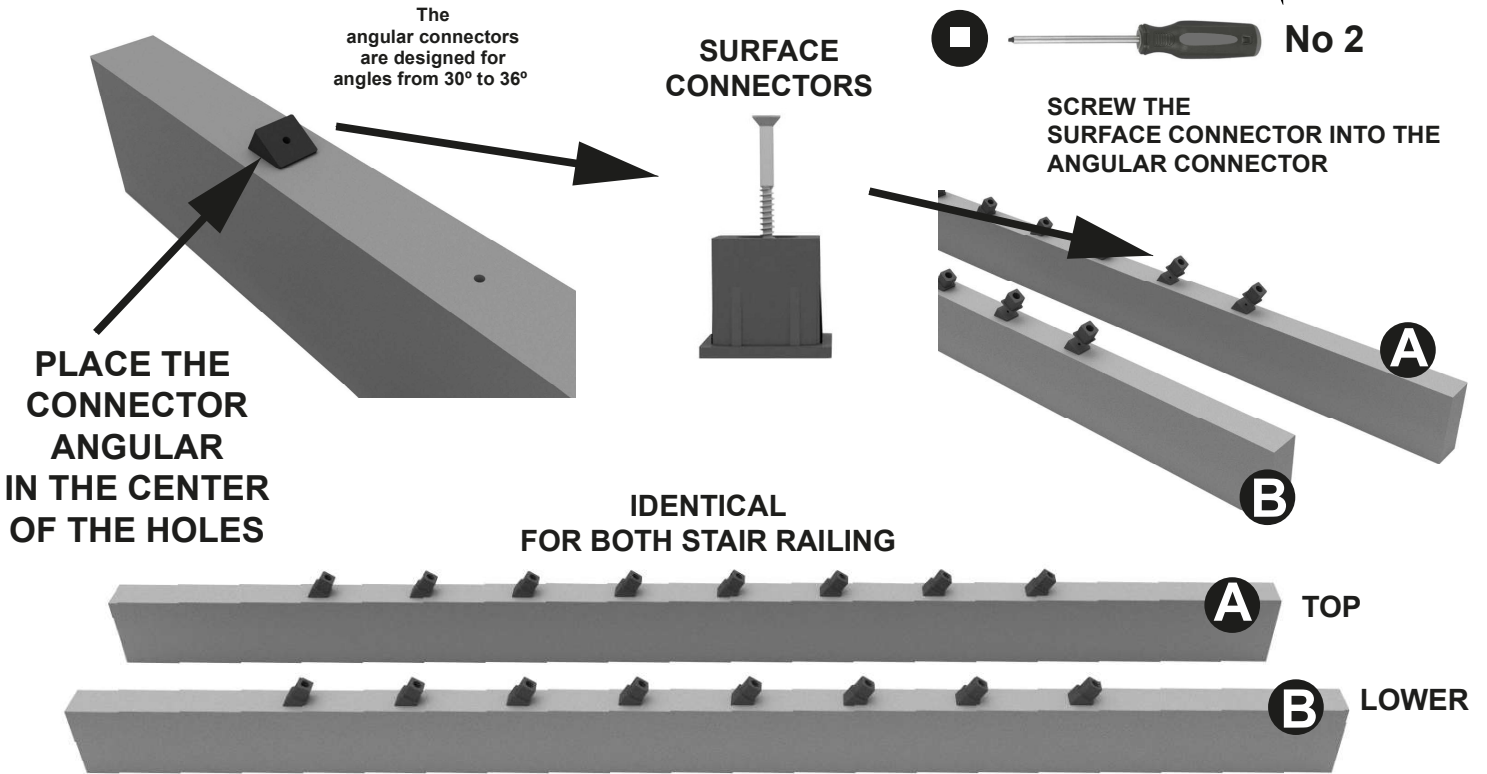

PLACE THE LOWER STAIR RAILING AS SHOWN

STEP 6 - INSTALLATION ON STAIR RAILING

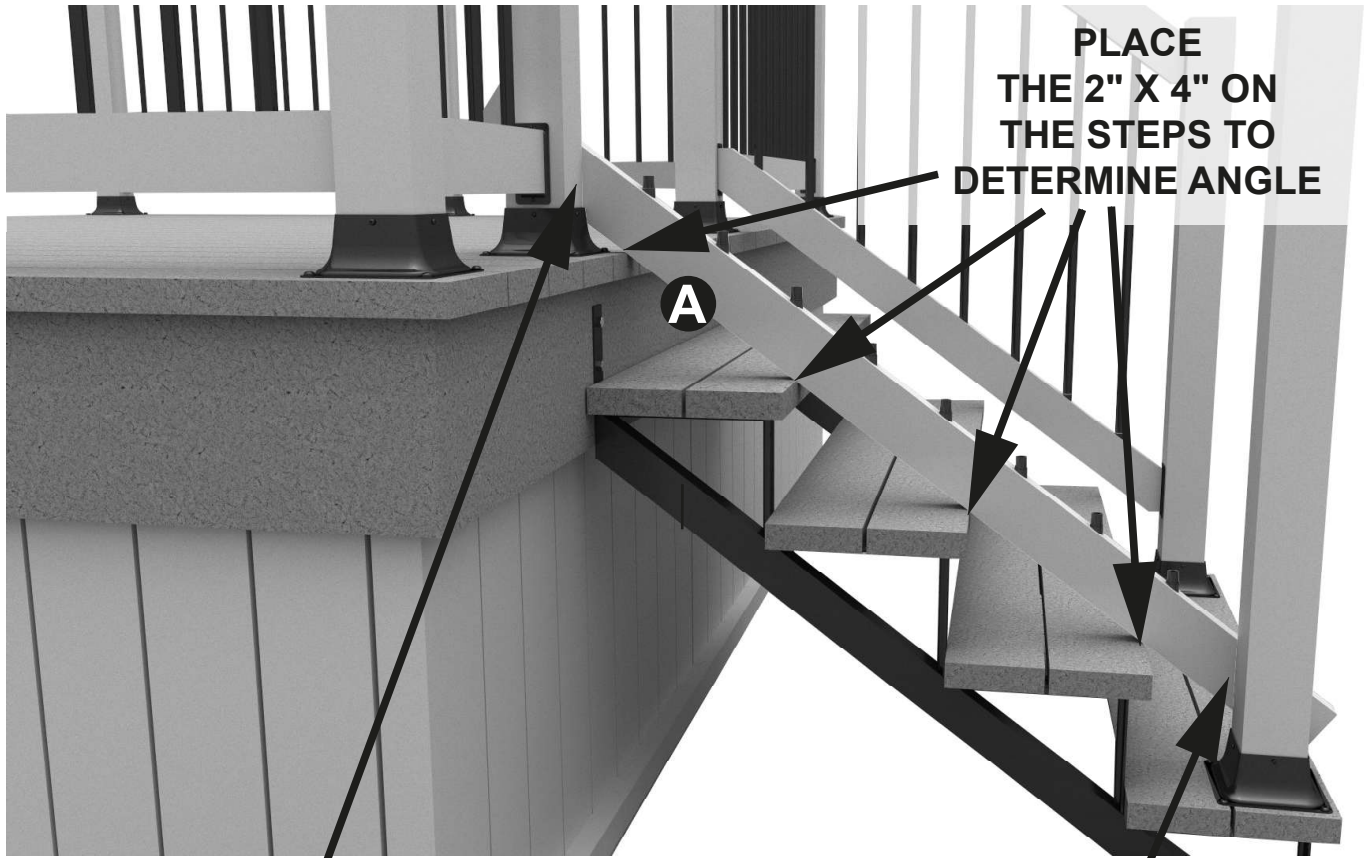

**LEAN THE RAILING AGAINST
THE POSTS AS ILLUSTRATED**

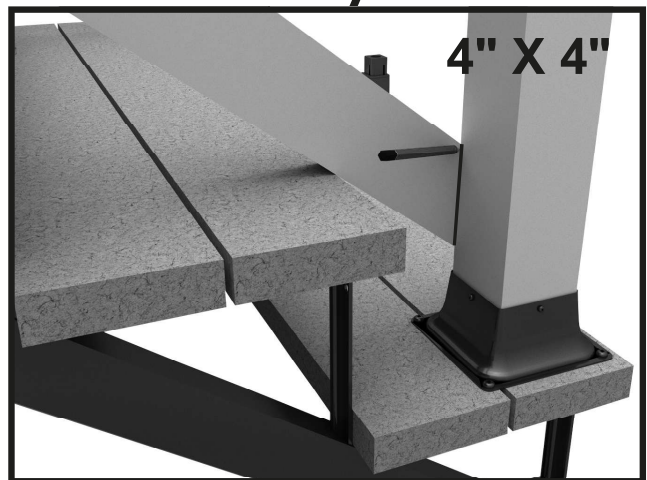
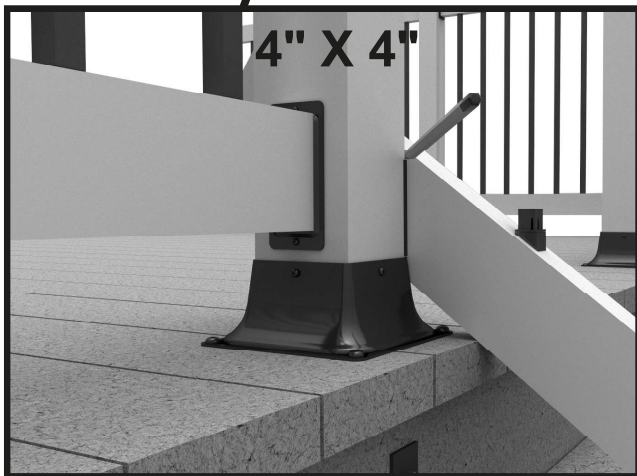

**DRAW AND CUT ALONG THE LINE
(for using with a Fixplak 24 - see page 9)**

STEP 7 - INSTALLATION ON STAIR RAILING



FIX THE LOWER STAIR RAILING TO THE POSTS (for using with a Fixplak 24)*

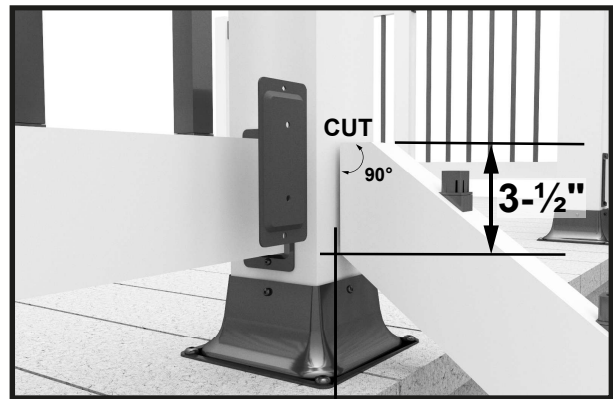
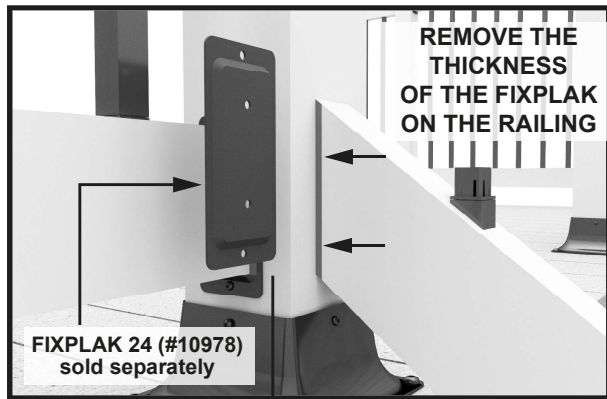

*ANOTHER INSTALLATION METHOD IS POSSIBLE

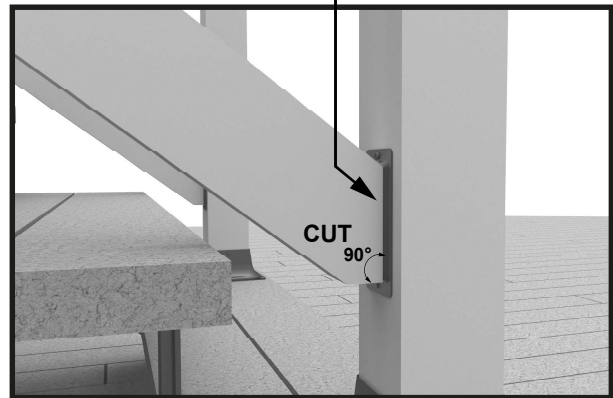
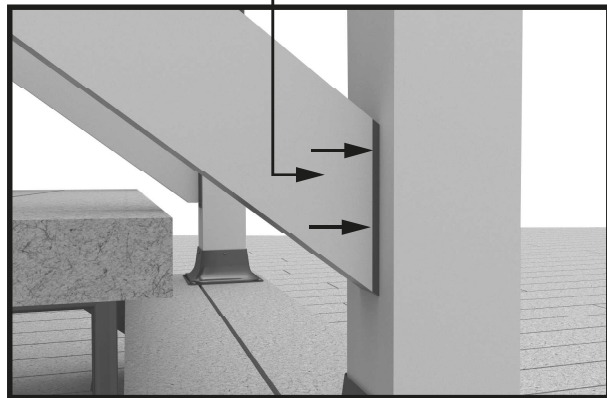

SAME PROCEDURE FOR THE TOP RAILING

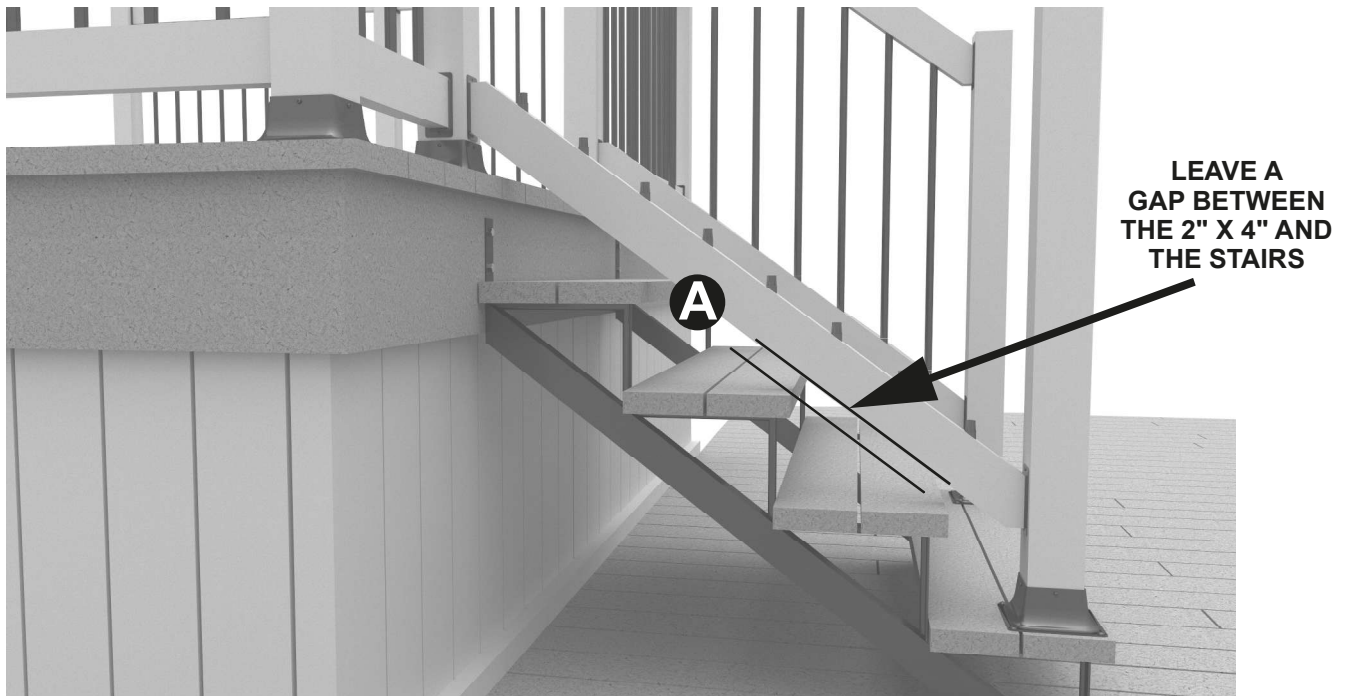

STEP 8 - INSTALLATION ON STAIR RAILING



THE BALUSTERS ARE SLIGHTLY SLOPING

INSTALL THE 2" X 4" ON THE BALUSTERS

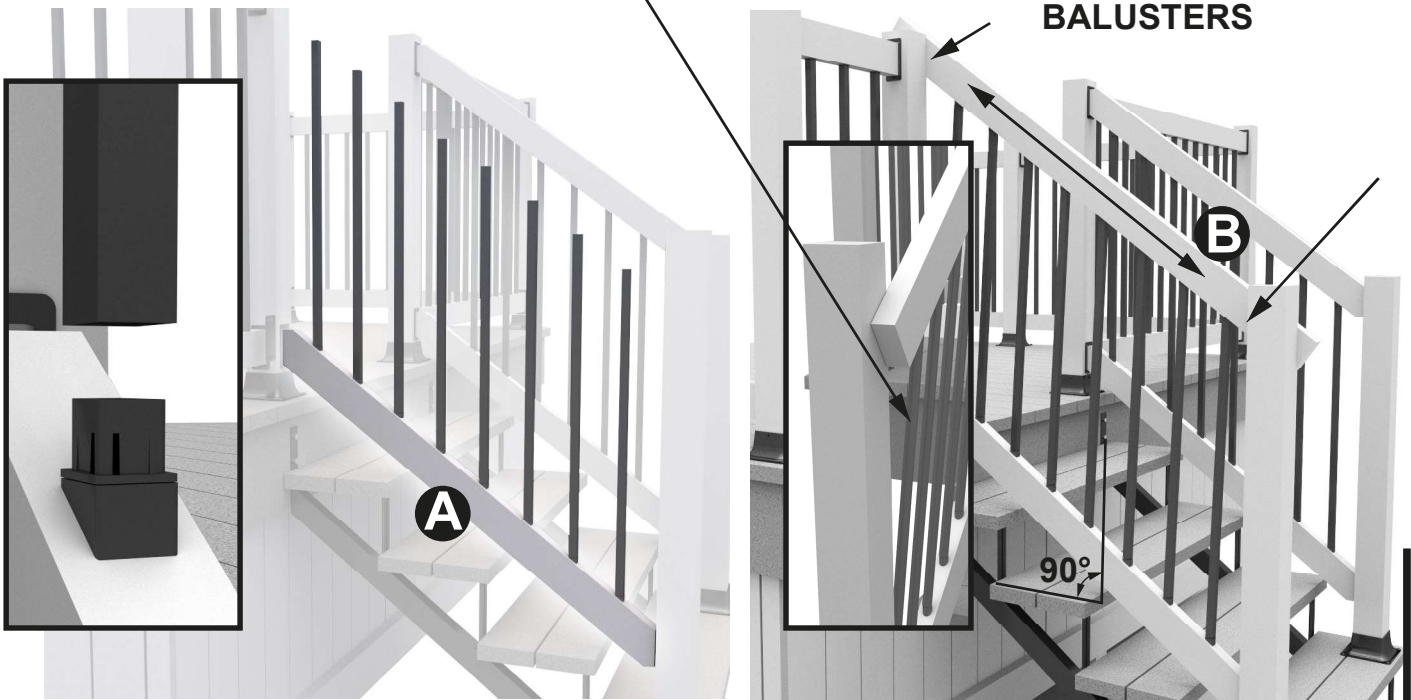

INSERT THE BALUSTERS INTO THE CONNECTORS
YOU MAY NEED TO CUT BALUSTERS FOR STAIR RAILING

ADJUST THE STAIR RAILING SO THAT THE BALUSTERS ARE STRAIGHT BY MOVING FROM LEFT TO RIGHT

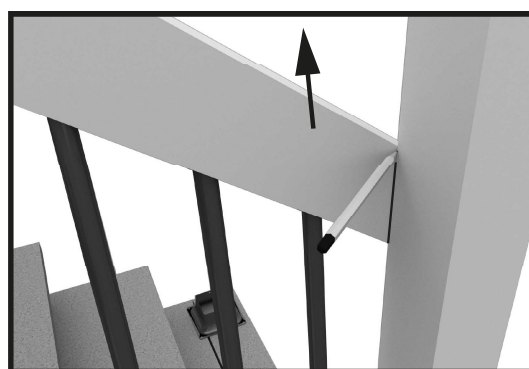
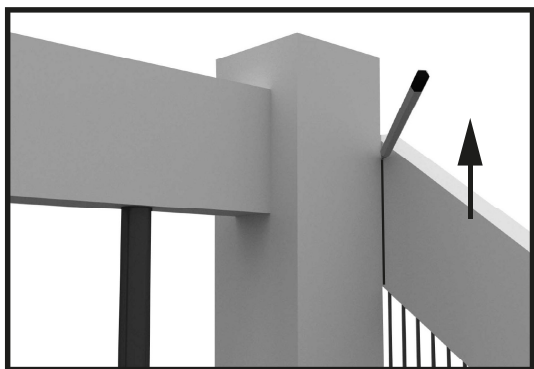

DRAW A LINE, REMOVE THE STAIR RAILING AND CUT ALONG THE LINE
(for using with a Fixplak 24 - see page 9)

STEP 9 - INSTALLATION ON STAIR RAILING

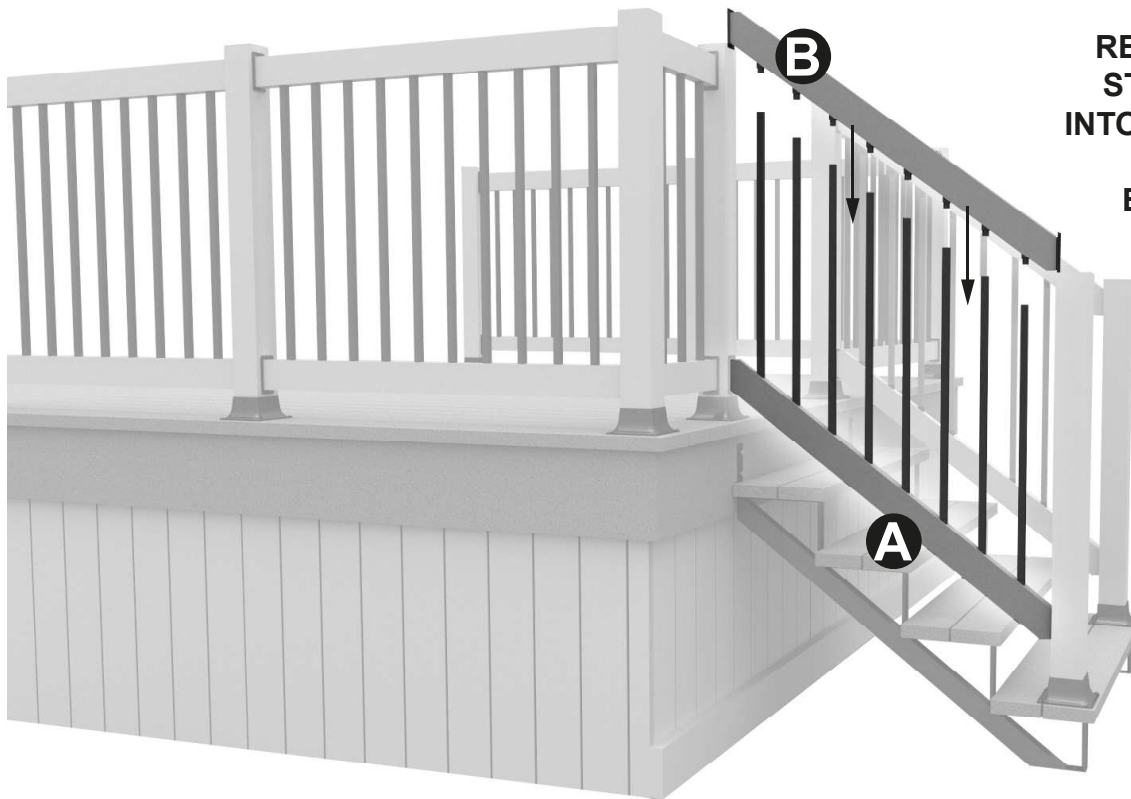

REINSTALL THE
STAIR RAILING
INTO THE ALREADY
INSTALLED
BALUSTERS



INSTALLATION TYPES
MAY VARY

FIX THE RAILING
TO THE POSTS



RATE US!



Satisfied with your Pylex product?

Please let us know by sharing pictures with us at info@pylex.com

You can also write a review online
about your purchase.

(By sending your image, you agree to give Pylex the right to it in its marketing activities).

Thank you!

YOU LIKED OUR PRODUCT?

Visit our website: www.pylex.com to see all our products
or **scan this QR code** to have access to our catalog!



Pylex Guarantee Certificate



Follow us on:

