



INSTALLATION GUIDE

ROUND BALUSTERS 26" - 32" - 36"

17126-27-32-33-36-37



Got a question? - Contact us:

First contact our friendly customer service team for assistance.

Email: info@pylex.com or phone: 1-800-264-1881

Monday to Friday: 8:30 am to 4:30 pm (EST)

Replacement for damaged or missing parts will be shipped promptly.

Rev.: 62-0529

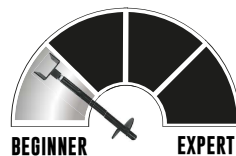

DECK AND FENCE HARDWARE

WWW.PYLEX.COM / 1 800-264-1881

NOTE: FOR STAIR RAILING, PRODUCT #17162 IS REQUIRED AND NOT INCLUDED.

MATERIALS and TOOLS REQUIRED

17126 - 17132 - 17136

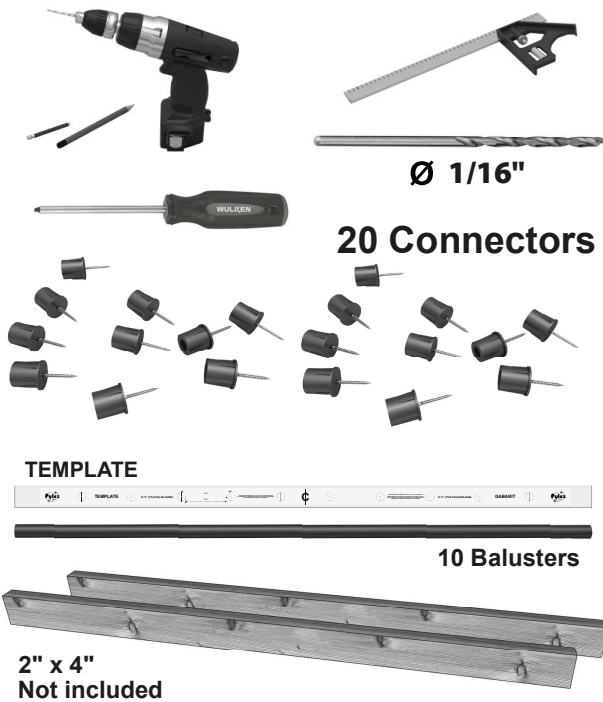

17127 - 17133 - 17137

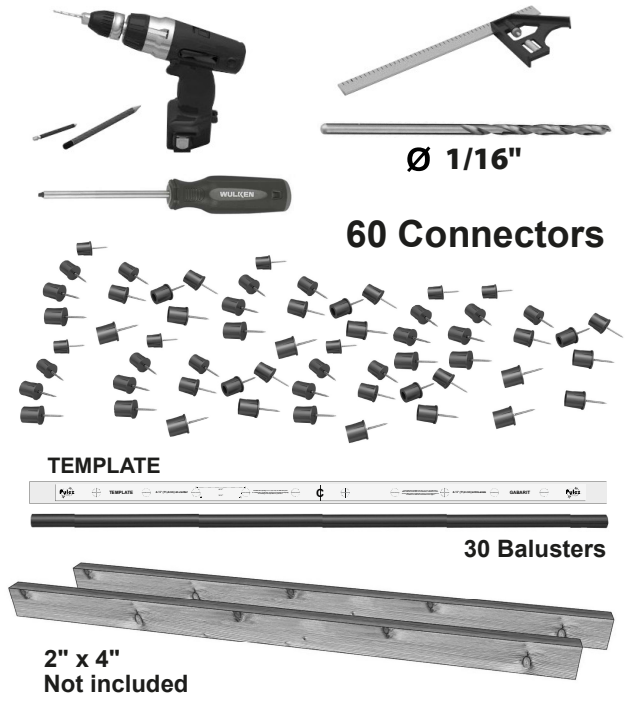

NUMBER OF BALUSTERS REQUIRED



DISTANCE		BALUSTERS
FROM	TO	
75- ³ / ₄ "	71- ¹ / ₂ "	16
71- ¹ / ₄ "	67"	15
66- ³ / ₄ "	62- ¹ / ₂ "	14
62- ¹ / ₄ "	58"	13
57- ³ / ₄ "	53- ¹ / ₂ "	12
53- ¹ / ₄ "	49"	11
48- ³ / ₄ "	44- ¹ / ₂ "	10
44- ¹ / ₄ "	40"	9

DISTANCE		BALUSTERS
FROM	TO	
39- ³ / ₄ "	35- ¹ / ₂ "	8
35- ¹ / ₄ "	31"	7
30- ³ / ₄ "	26- ¹ / ₂ "	6
26- ¹ / ₄ "	22"	5
21- ³ / ₄ "	17- ¹ / ₂ "	4
17- ¹ / ₄ "	13"	3
12- ³ / ₄ "	8- ¹ / ₂ "	2
8- ¹ / ₄ "	4"	1

MEASURE THE DISTANCE BETWEEN POSTS

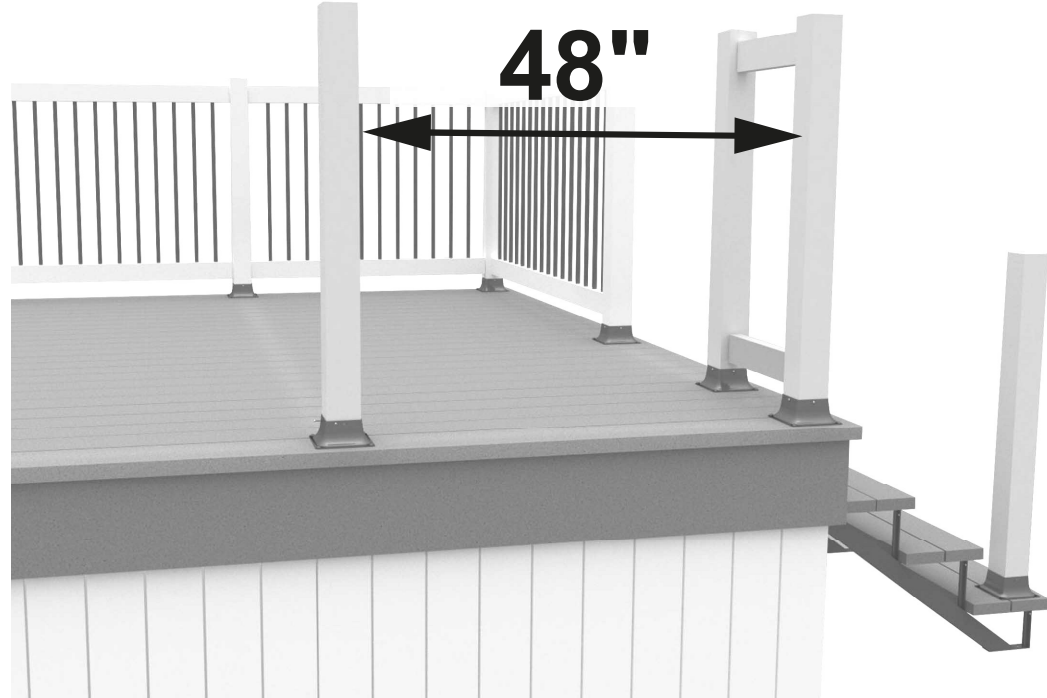

see table
page 2
48"*
10 balusters

USE TWO 2" X 4" PIECES LONGER THAN THE FINAL MEASUREMENT (55")*



4-1/2"
SPACE BETWEEN OF BALUSTERS

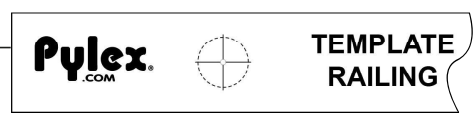

USING A POINTED OBJECT, MARK ALL THE MARKS (NAIL / PUNCH)

USE A SQUARE TO DRAW A LINE ON THE TOP 2" X 4"

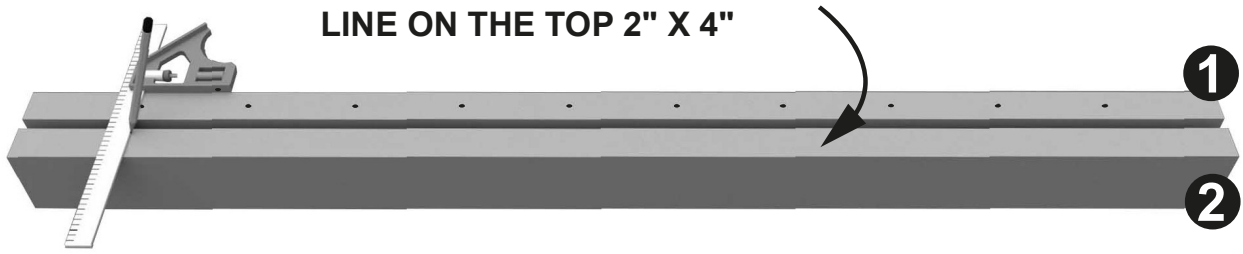

PRE-DRILL ALL MARKS ON THE TOP 2" X 4"

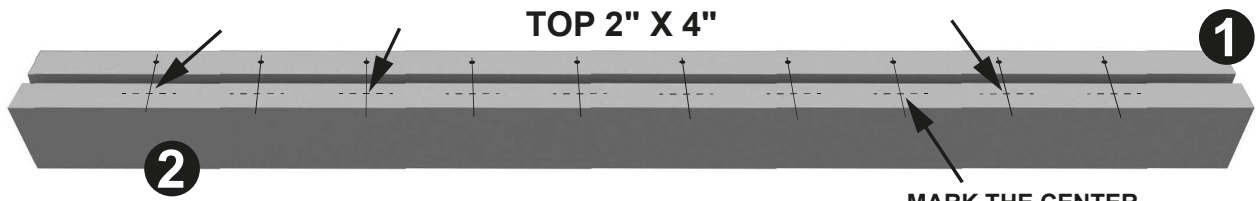

MARK THE CENTER

***USE YOUR MEASUREMENTS**

STEP 2 - INSTALLATION ON THE RAILING



SURFACE CONNECTORS



SCREW THE CONNECTORS INTO THE PRE-DRILLED HOLES

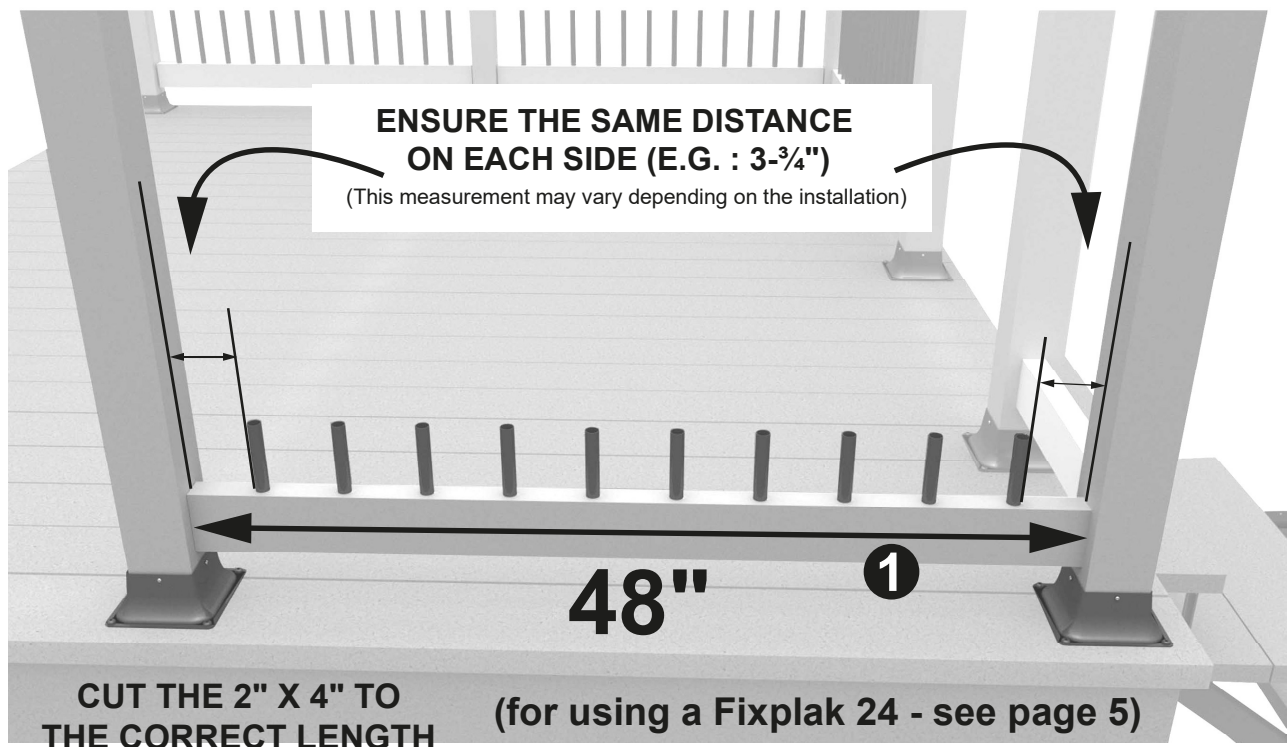
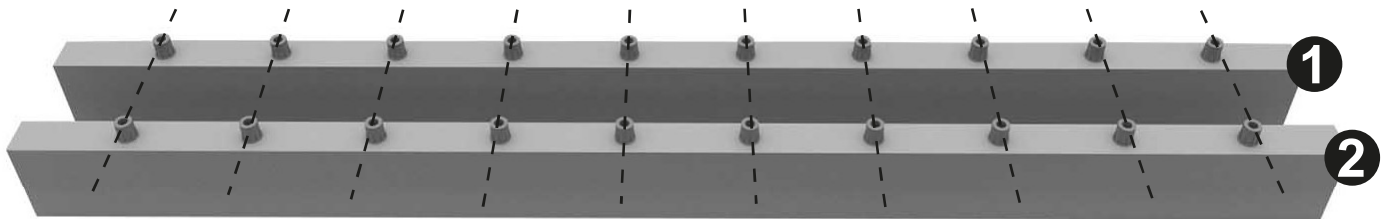

STEP 3 - INSTALLATION ON THE RAILING



ASSEMBLE THE BALUSTERS AS SHOWN

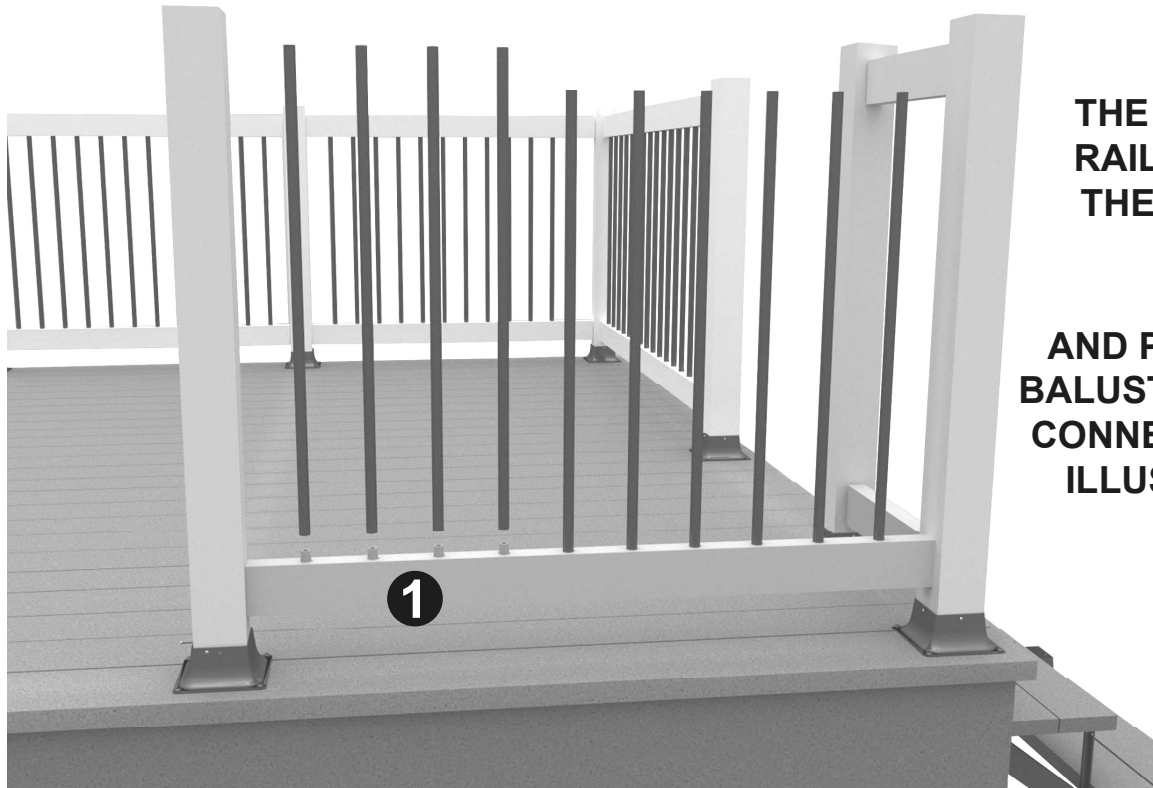

FIX THE LOWER RAILING TO THE POSTS

AND PLACE THE BALUSTERS IN THE CONNECTORS AS ILLUSTRATED.

FIX THE RAILING TO THE POSTS

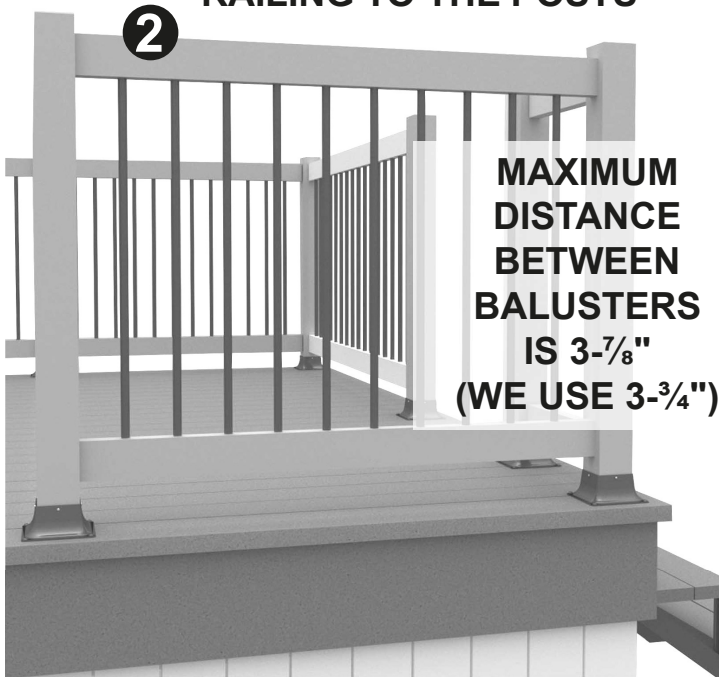

INSTALL THE UPPER RAILING INTO THE ALREADY INSTALLED BALUSTERS

USING A FIXPLAK 24
sold separately

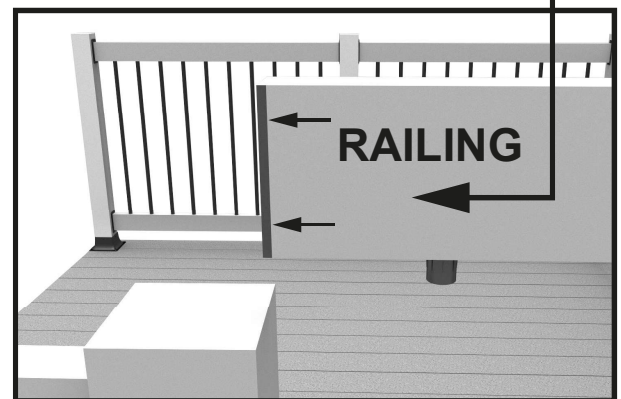
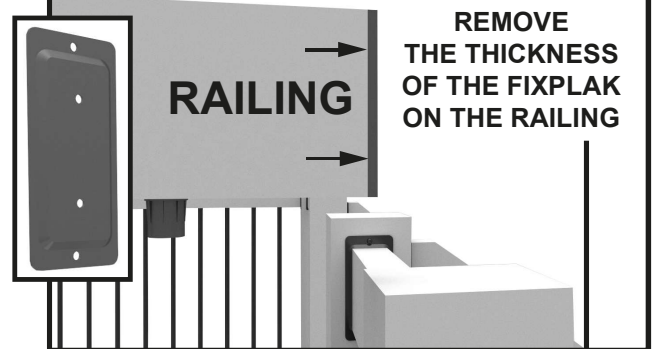

STEP 4 - INSTALLATION ON STAIR RAILING

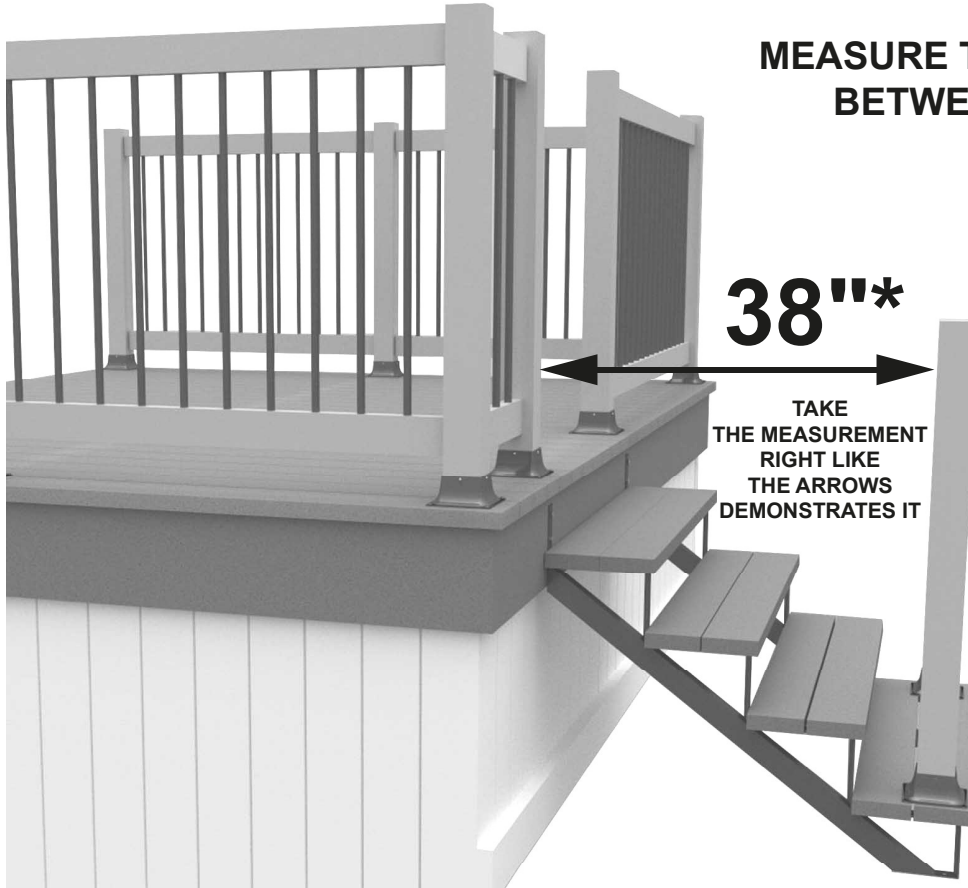

MEASURE THE DISTANCE BETWEEN POSTS

38"*

TAKE THE MEASUREMENT RIGHT LIKE THE ARROWS DEMONSTRATES IT

SEE THE TABLE PAGE 2
8 balusters

5-1/2"

SPACE BETWEEN OF BALUSTERS

USE TWO 2" X 4" LONGER THAN THE FINAL MEASUREMENT (55")*



TEMPLATE STAIR RAILING



USING A POINTED OBJECT, MARK ALL THE MARKS (NAIL / PUNCH)

USE A SQUARE TO DRAW A LINE ON THE TOP 2" X 4"

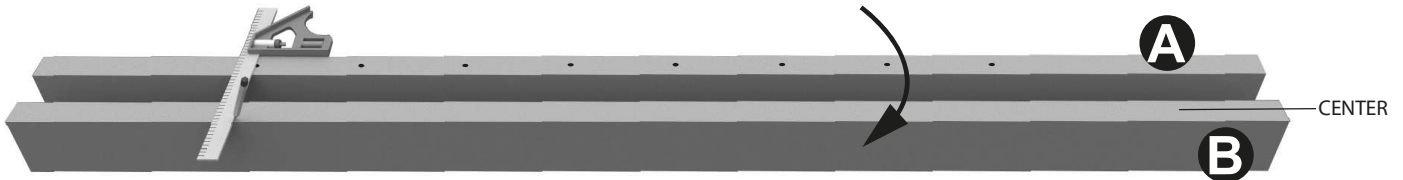

PRODUCT # 17162
NOT INCLUDED

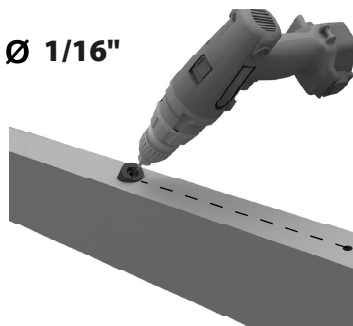

USING PRODUCT #17162 / PRE-DRILL ALL MARKS

PRODUCT #17162 SERVES AS YOUR GUIDE

MARK THE CENTER

STEP 5 - INSTALLATION ON STAIR RAILING

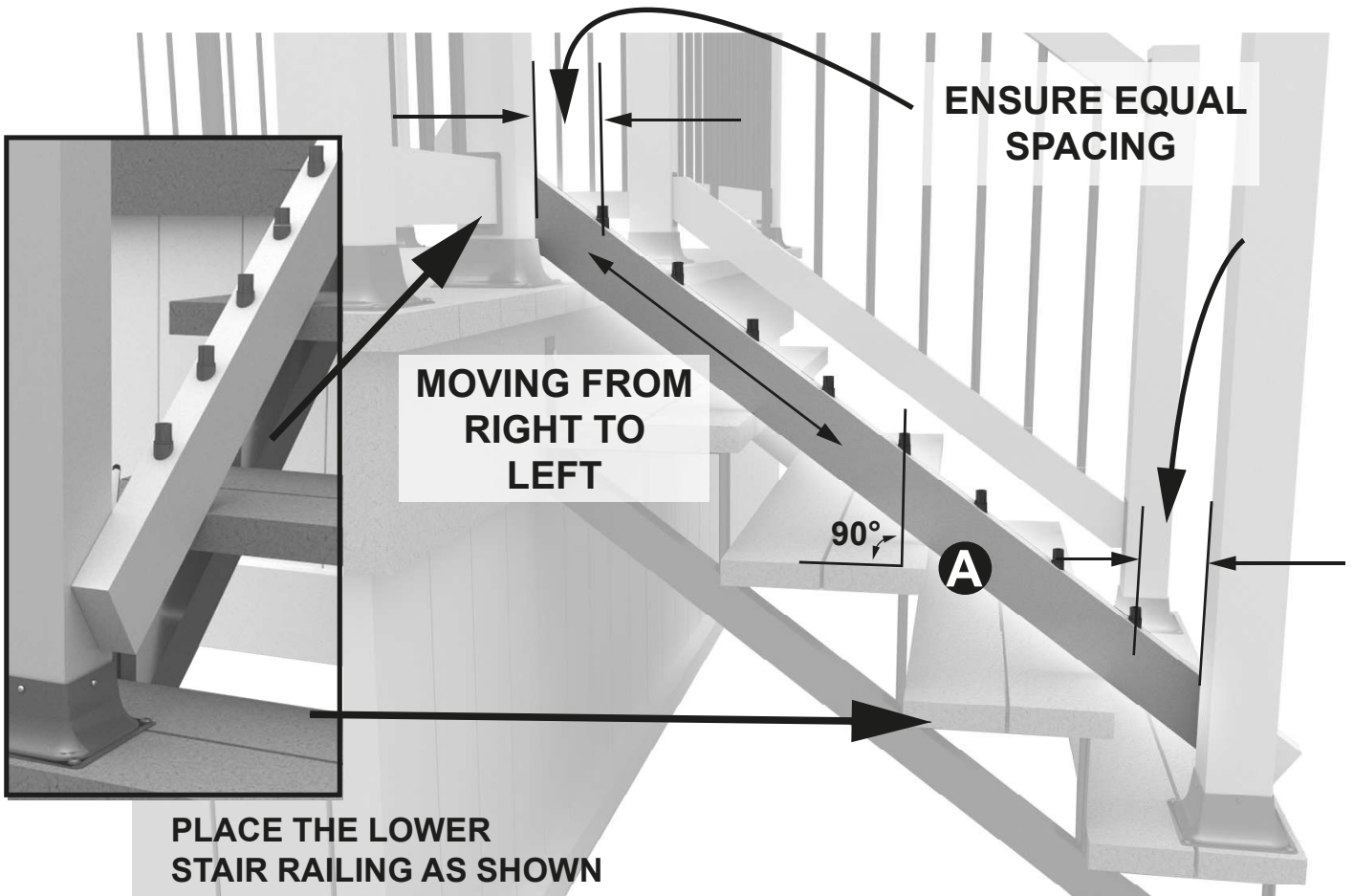
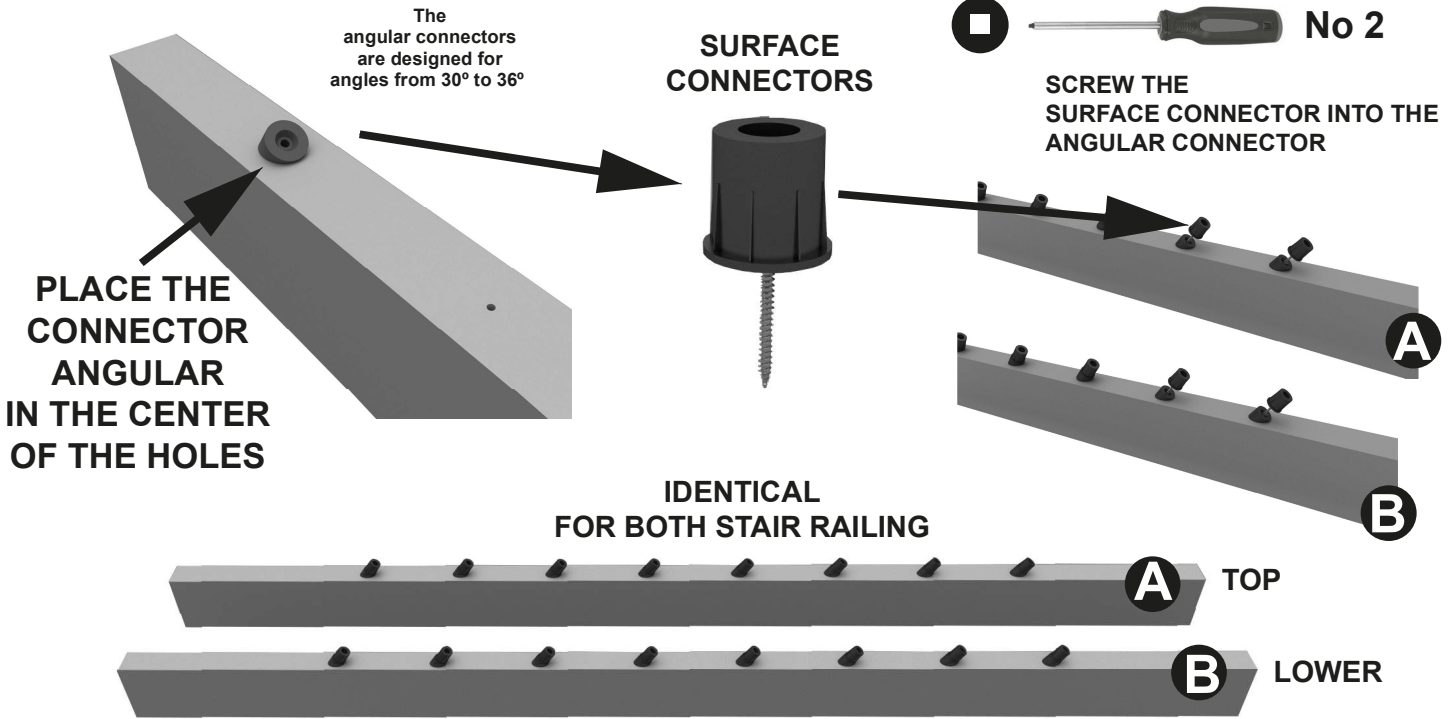

STEP 6 - INSTALLATION ON STAIR RAILING

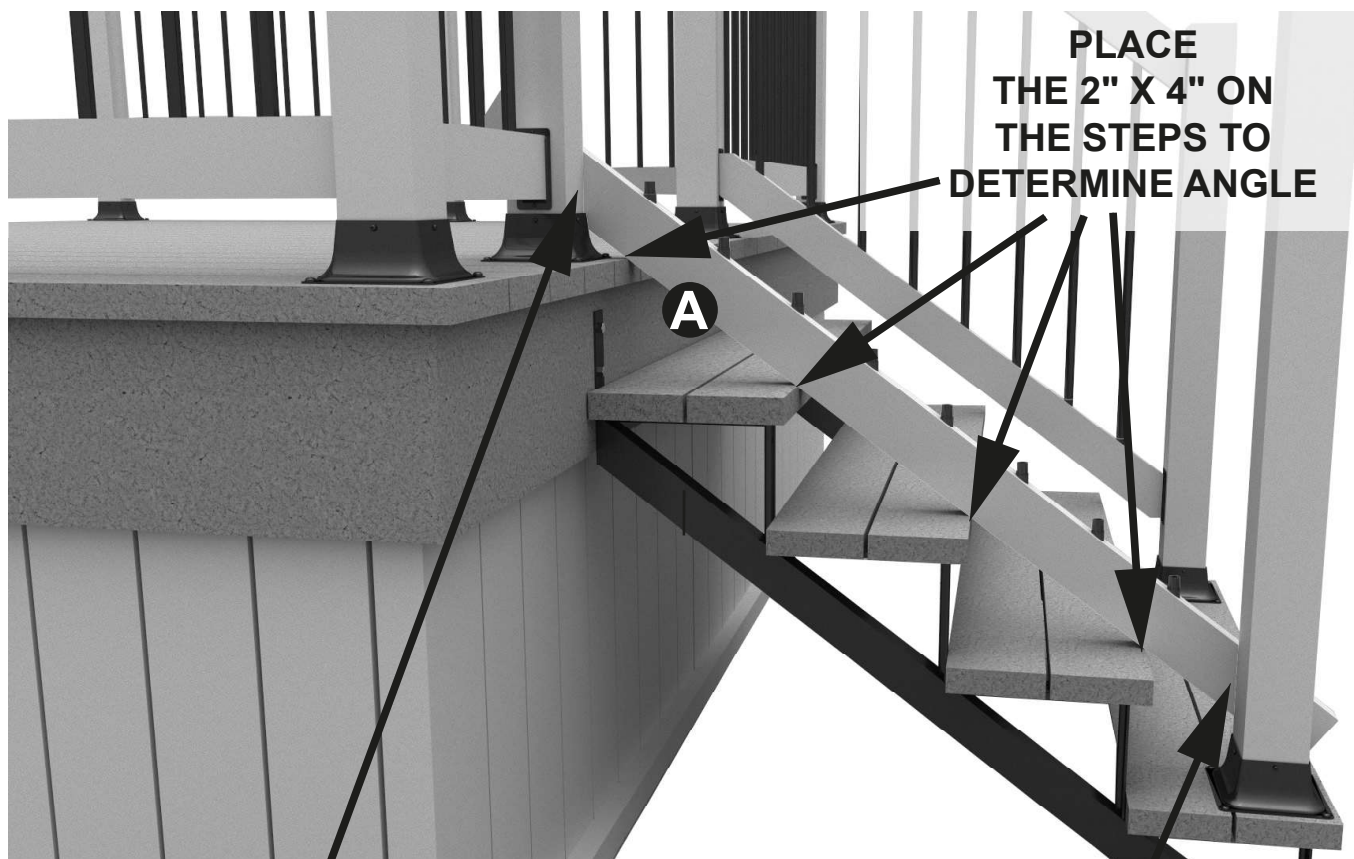

LEAN THE RAILING AGAINST THE POSTS AS ILLUSTRATED

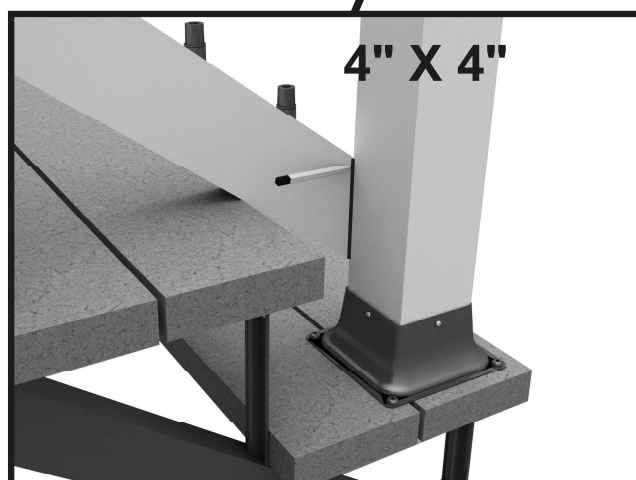
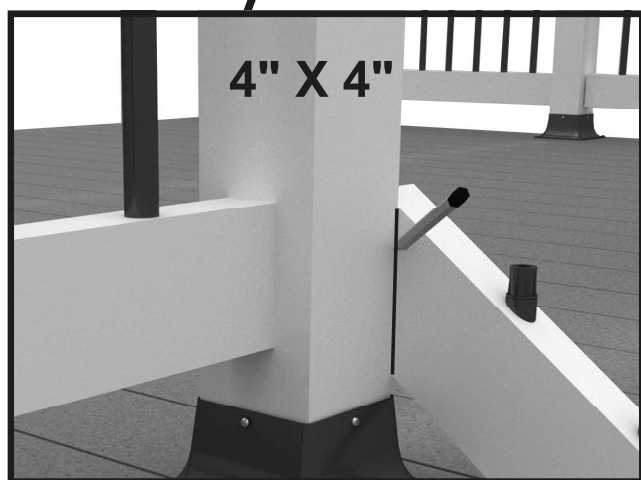

DRAW AND CUT ALONG THE LINE
(for using a Fixplak 24 - see page 9)

STEP 7 - INSTALLATION ON STAIR RAILING



FIX THE LOWER STAIR RAILING TO THE POSTS (for using with a Fixplak 24)*

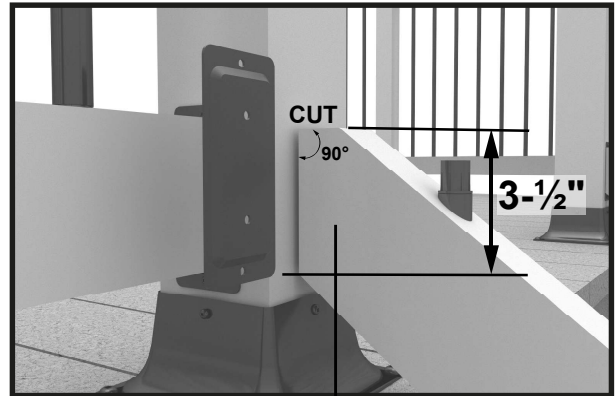
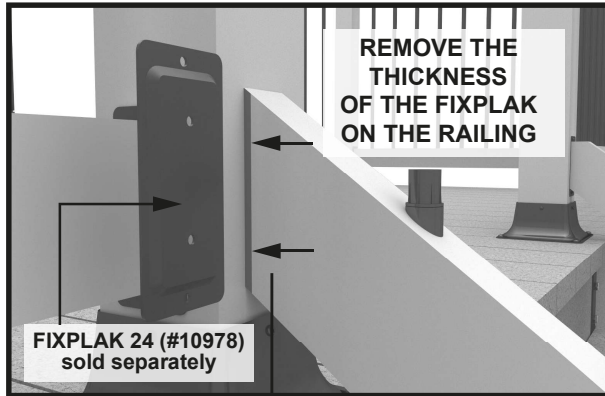

*ANOTHER INSTALLATION METHOD IS POSSIBLE

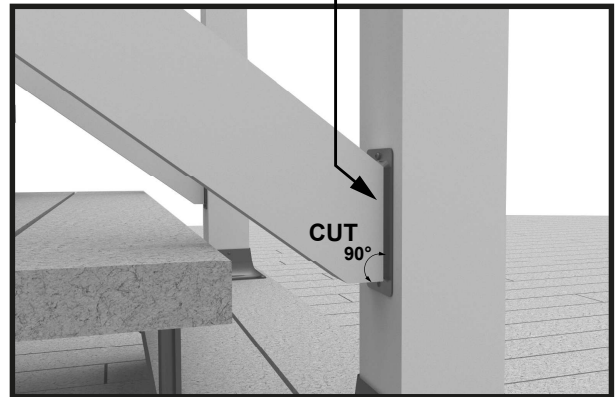
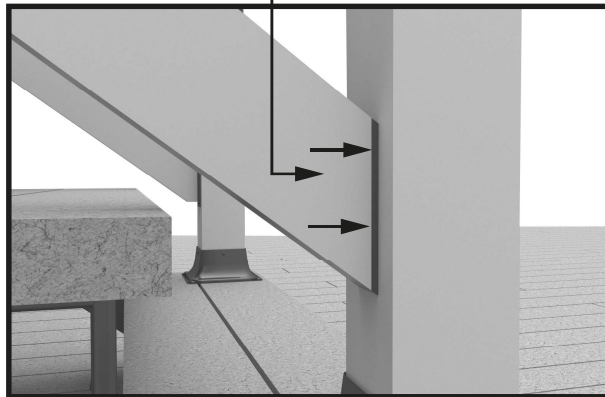

SAME PROCEDURE FOR THE TOP RAILING

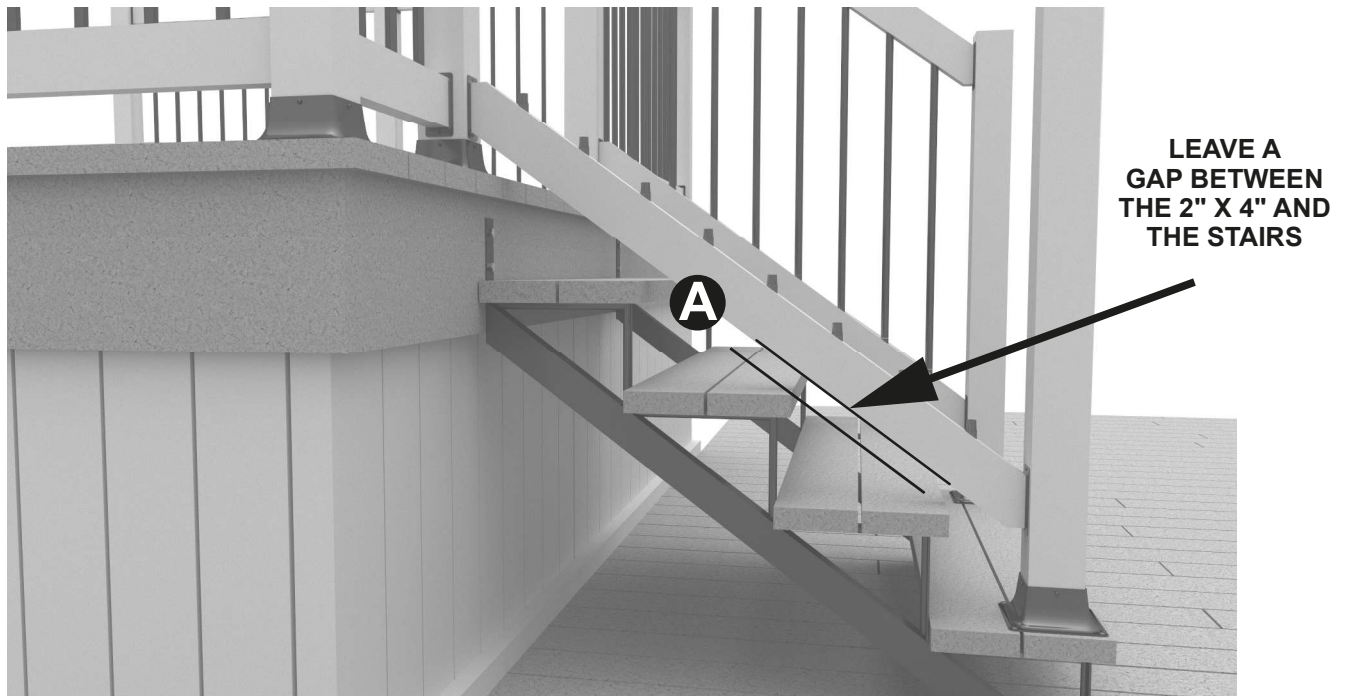

STEP 8 - INSTALLATION ON STAIR RAILING



THE BALUSTERS
ARE SLIGHTLY SLOPING

INSTALL THE
2" X 4" ON THE
BALUSTERS

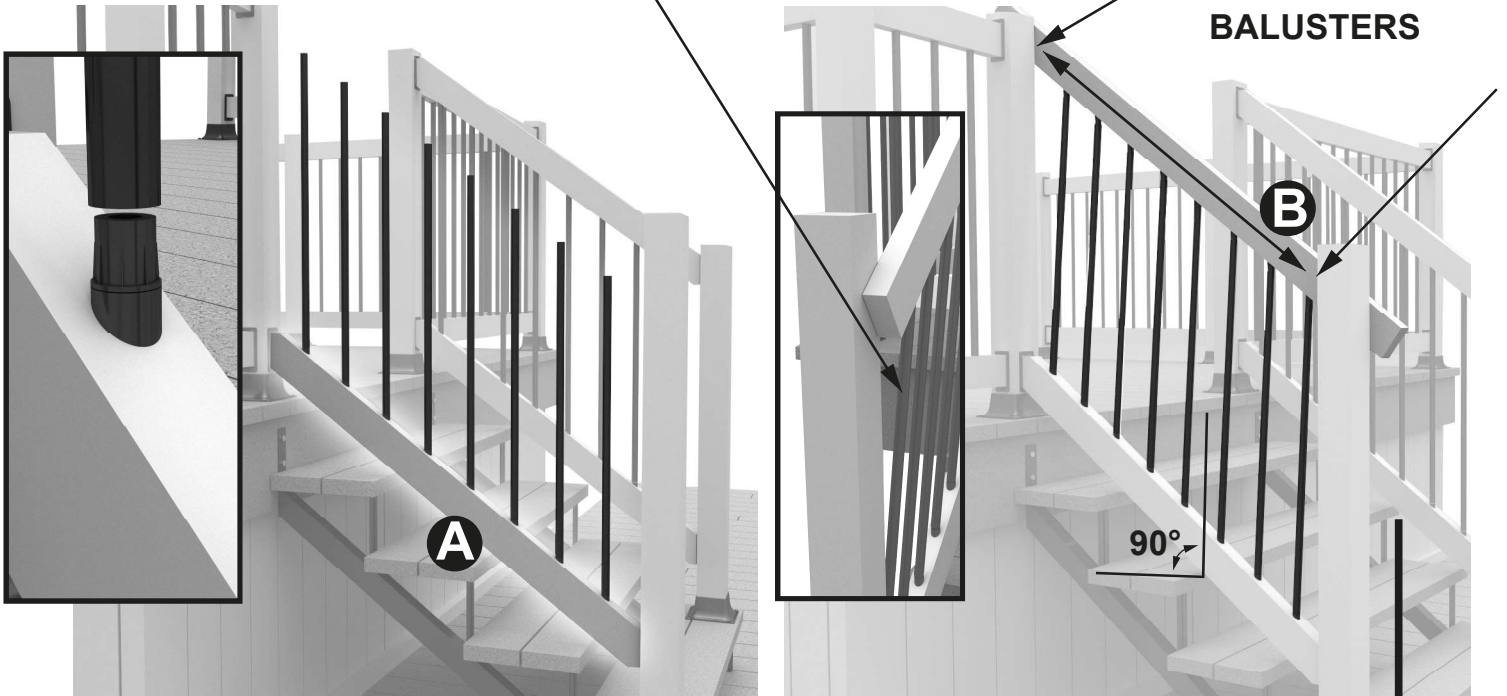

**INSERT THE BALUSTERS
INTO THE CONNECTORS**
YOU MAY NEED TO CUT BALUSTERS
FOR STAIR RAILING

**ADJUST THE STAIR RAILING
SO THAT THE
BALUSTERS ARE STRAIGHT
BY MOVING
FROM LEFT TO RIGHT**

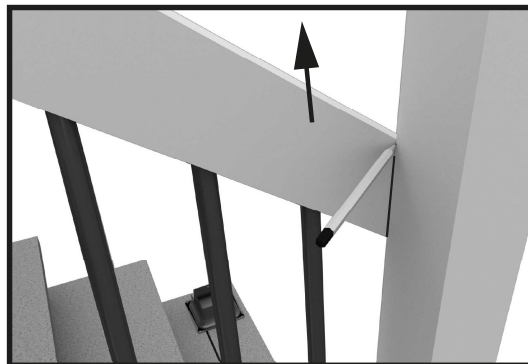
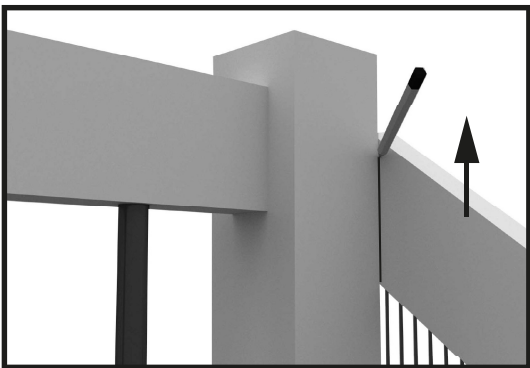

**DRAW A LINE, REMOVE THE STAIR
RAILING AND CUT ALONG THE LINE**
(for using a Fixplak 24 - see page 9)

STEP 9 - INSTALLATION ON STAIR RAILING



**REINSTALL THE
STAIR RAILING
INTO THE ALREADY
INSTALLED
BALUSTERS**



**FIX THE RAILING
TO THE POSTS**



**INSTALLATION TYPES
MAY VARY**



RATE US!



Satisfied with your Pylex product?

Please let us know by sharing pictures with us at info@pylex.com

You can also write a review online
about your purchase.

(By sending your image, you agree to give Pylex the right to it in its marketing activities).

Thank you!

YOU LIKED OUR PRODUCT?

Visit our website: www.pylex.com to see all our products
or scan this QR code to have access to our catalog!



Pylex Guarantee Certificate



Follow us on:

