

**PRODUCT CATALOGUE
CATALOGUE DES PRODUITS**

DECK AND FENCE HARDWARE
ACCESSOIRES - PATIO / CLÔTURE



2024



400, rue du Parc-Industriel, Shawinigan, Qc. Canada G9N 6T5
1 800 264-1881 / www.pylex.com

inspirations



400, rue du Parc-Industriel

Shawinigan, QC, Canada

G9N 6T5

1-800-264-1881

WWW.PYLEX.COM



ORDER / COMMANDE

orderdesk@pylex.com

**TECHNICAL SUPPORT /
SOUTIEN TECHNIQUE**

info@pylex.com

1-800-264-1881

CHAT / CLAVARDAGE

www.pylex.com

**ALL OUR STEEL PRODUCTS ARE COATED WITH BAKED POWDER PAINT FOR EXCELLENT RUST RESISTANCE
TOUS NOS PRODUITS EN ACIER ONT UNE PEINTURE EN POUDRE CUITE OFFRANT UNE EXCELLENTE RÉSISTANCE À LA ROUILLE**

Ask your Pylex representative for the availability of:

- Display stand, demos, guide, assembly plan for demos, plano...
We have plenty of resources to help you!

**Renseignez-vous auprès de votre
représentant Pylex pour la disponibilité de :**

- Présentoir, démos, guide, plan de montage pour démos, plano...
Nous avons beaucoup d'outils pour vous aider!





HELICAL PILE / VIS DE FONDATION

Product Code Produit	Product name / Nom du produit	Category Catégorie	Page	Other category Autre catégorie
10505	Pylex Regular 50" / Pylex régulier 50"	Helical pile / Vis de fondation	08	Deck / Patio
10555 10565	Adjustable Pylex Pylex ajustable	Helical pile / Vis de fondation	09	Deck / Patio
10571	24" Extension / Rallonge 24"	Helical pile / Vis de fondation	10	Deck / Patio
10575	Lateral Stabilizer / Stabilisateur latéral	Helical pile / Vis de fondation	10	Deck / Patio
10725	Pylex-L	Helical pile / Vis de fondation	11	Fence / Clôture
10730	Commercial Pylex 66 / Pylex Commercial 66	Helical pile / Vis de fondation	12	Fence / Clôture

FENCE / CLÔTURE

Product Code Produit	Product name / Nom du produit	Category Catégorie	Page	Other category Autre catégorie
13020 - 13022	Adj. Spytek Ajustable 112 / 178 / 238	Fence / Clôture	13	
13015	Spytek 22 Adjustable / Spytek 22 Ajustable	Fence / Clôture	13	
13076 - 13079	Spybase	Fence / Clôture	14	
14105	Post Repair Kit / Ens. de réparation de poteau	Fence / Clôture	14	
11057	Heavy Duty Sliding Gate Kit Quinc. porte coulissante sur rail	Fence / Clôture	15	
13090	Latitude System / Système Latitude	Fence / Clôture	16	Gazebo/Pergola Outdoor Furniture / Mobilier extérieur
12987 - 13014	Spikes / Pieu à enfoncer	Fence / Clôture	17	

DECK / PATIO

Product Code Produit	Product name / Nom du produit	Category Catégorie	Page	Other category Autre catégorie
12095 - 12099	Adjustable Deck Support / Support de patio ajustable	Deck / Patio	18	
12114 12117/18	Deck Track / Bande de fixation pour patio	Deck / Patio	19	
12090 12091	Joist Waterproof Strip / Bande imperméable pour solive	Deck / Patio	20	
12110	J-Fix	Deck / Patio	20	
11055	Self-Leveling Latch / Loquet autonivelant	Deck / Patio	21	Fence / Clôture
13003	Adjustable Spytekdeck / Spytekdeck ajustable	Deck / Patio	21	
11050 11051	Gate Kit / Quincaillerie pour barrière	Deck / Patio	22	Fence / Clôture
11052	Sliding Gate Kit / Quincaillerie de barrière coulissante	Deck / Patio	23	Fence / Clôture
12100	Suplak 44	Deck / Patio	24	
13063 13064	Concrete Anchor / Ancrage à béton	Deck / Patio	24	Fence / Clôture
12840 12841	Concrete "U" Saddle (<i>dressed</i>) / Support en «U» pour béton	Deck / Patio	24	Fence / Clôture
11090	Fixrail	Deck / Patio	25	Fence / Clôture
10900 - 12055	Fixplak 23/24/24H/26	Deck / Patio	25	Fence / Clôture
10800 - 11045	Fixplak 44/66	Deck / Patio	26	
12000 - 12012	Plakcap 44	Deck / Patio	26	
12020 - 12039 & 13045 - 13049	Cap 44 & Base 44	Deck / Patio	27	Fence / Clôture
13042 13062	Fixbase 44	Deck / Patio	28	
13040/41 - 13060/61	Bolt Down 44/66 / Base de fixation 44/66	Deck / Patio	28	
11060 11070	Deck Sunblind System/ Système de Store pour patio	Deck / Patio	29	Fence / Clôture
13070	Outaboundz Bracket / Étrier Horslimits	Deck / Patio	30	
12080	Deck Storage Drawer / Tiroir de rangement pour patio	Deck / Patio	31	

STAIR STRINGERS & STAIR TREADS LIMONS ET MARCHES

Product Code / Produit	Product name / Nom du produit	Category / Catégorie	Page
14201	Universal Stair Stringer / Limon universel	Stair stringers & stair treads / Limons et marches	32
13120 13165 - 13175	Stair Fastening Strip / Bande de fixation pour limon Adj. Stair Bracket / Syst. de limon ajustable	Stair stringers & stair treads / Limons et marches	32
13941 - 13945	Steel Stair Tread 11" / Marche en acier 11"	Stair stringers & stair treads / Limons et marches	33 
13925	Central Steel Stringer System / Système pour limon central en acier	Stair stringers & stair treads / Limons et marches	34 
13901 - 13907	Steel Stair Stringers / Limons en acier	Stair stringers & stair treads / Limons et marches	35
13920	Steel Stringer Connector / Connecteur pour limon acier	Stair stringers & stair treads / Limons et marches	36
14136 - 14149	Aluminum Stair Treads 9-3/4" Coll.10 / Marche en aluminium 9-3/4" Coll.10	Stair stringers & stair treads / Limons et marches	37
14021 - 14065	Aluminum Stair Stringers 9-1/6" Coll.10 / Limons d'aluminium 9-1/6" Coll.10	Stair stringers & stair treads / Limons et marches	38 - 39
16136 - 16149	Aluminum Stair Treads 11" Coll.11 / Marches d'aluminium 11" Coll.11	Stair stringers & stair treads / Limons et marches	40
16001 - 16037	Aluminum Stair Stringers 10-1/4" Coll.11 / Limons aluminium 10-1/4" Coll.11	Stair stringers & stair treads / Limons et marches	41
16020 16050	Alu. Stringer Connector & Post Coll.11 / Connecteur + poteau pour limon alu. Coll.11	Stair stringers & stair treads / Limons et marches	42

GAZEBO / PERGOLA / OUTDOOR FURNITURE / MOBILIER EXTÉRIEUR

Product Code / Produit	Product name / Nom du produit	Category / Catégorie	Page	Other category / Autre catégorie
12071 - 12073	Pergola Hardware / Quincaillerie pour pergola	Gazebo / Pergola / Outdoor furniture / Mobilier extérieur	43 - 44	
12075	Gazebo Roof Bracket / Ensemble de supports pour toiture de gazebo	Gazebo / Pergola / Outdoor furniture / Mobilier extérieur	45	
14300 - 14302	Bench Bracket / Support de banc	Gazebo / Pergola / Outdoor furniture / Mobilier extérieur	46	Deck / Patio
12085	Swing Bracket Kit / Quincaillerie pour balançoire	Gazebo / Pergola / Outdoor furniture / Mobilier extérieur	47	
12082	Glider Bench Kit / Quincaillerie pour banc coulissant	Gazebo / Pergola / Outdoor furniture / Mobilier extérieur	48	

ACCESSORIES / ACCESSOIRES

Product Code Produit	Product name / Nom du produit	Category Catégorie	Page	Other category Autre catégorie
10736 10738	Clothesline Post / Poteau de corde à linge	Accessories / Accessoires	49	
12060 12061	2 X 4 Rack Structure / Structure de rangement	Accessories / Accessoires	50 - 51	
12120	Removable Floor Anchor / Ancrage à plancher amovible	Accessories / Accessoires	52	
13050 - 13053	Cable Anchor / Ancrage à câble	Accessories / Accessoires	52	
14011 14012	Roof Bracket / Étrier à toiture	Accessories / Accessoires	53	
13510	Retractable Shelter 10' x 10' / Abri rétractable 10' x 10'	Accessories / Accessoires	54	

PLATFORM / PLATEFORME

Product Code Produit	Product name / Nom du produit	Category Catégorie	Page	Other category Autre catégorie
10705 - 10707	Pylex Power Elevator (50", 32", Platform / Plateforme)	Platform / Plateforme	55 - 57	

BY PRODUCT NUMBER / PAR NUMÉRO DE PRODUIT

Product Produit #	Page	Product Produit #	Page	Product Produit #	Page	Product Produit #	Page	Product Produit #	Page	Product Produit #	Page	Product Produit #	Page
10505	08	10900	25	11045	26	12035	27	12100	24	13063-64	24	14028-35	39
10555	09	10910	25	11050-51	22	12038-39	27	12110	20	13070	30	14051-57	38
10565	09	10920	25	11052	23	12040	25	12114	19	13076-79	14	14058-65	39
10571/75	10	10930	25	11055	21	12045	25	12117-18	19	13090	16	14105	14
10705	56	10940	25	11057	15	12050	25	12120	52	13120	32	14136-39	37
10706	57	10955	25	11060	29	12055	25	12840-41	24	13165	32	14141-44	37
10707	55	10965	25	11070	29	12060	50	12987-88	17	13170	32	14146-49	37
10725	11	10975	25	11090	25	12061	51	13002	17	13175	32	14201	32
10730	12	10978-80	25	12000	26	12071-72	43	13003	21	13180	32	14300-02	46
10736	49	10990	25	12005	26	12073	44	13012-14	17	13510	54	16001-07	41
10738	49	11000	25	12010	26	12075	45	13015	13	13901-07	35	16020	42
10800	26	11008-09	25	12012	26	12080	31	13020-22	12	13920	36	16031-37	41
10810	26	11010	26	12020	27	12082	48	13040-42	28	13925	34	16050	42
10820	26	11020	26	12023	27	12085	47	13045-49	27	13941-45	33	16136-39	40
10830	26	11030	26	12025	27	12090-91	20	13050-53	52	14011-12	53	16141-44	40
10840	26	11040	26	12030	27	12095-99	18	13060-62	28	14021-27	38	16146-49	40

**CAPTION
OF ICONS /
LÉGENDE
DES ICÔNES**



FENCE/
CLÔTURE



PERGOLA



GAZEBO



DECK
PATIO



NO NEED TO DIG
OR POUR CONCRETE /
PAS BESOIN DE CREUSER
OU DE COULER DU BÉTON

**STEEL
ACIER**



**REGULAR PYLEX 50"
PYLEX RÉGULIER 50"**

Screwable deck post anchor / Vis d'ancrage pour patio

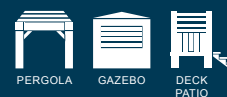

- Easiest and most efficient way to support a deck, shed or patio
- No digging, no concrete
- Substitute for concrete forms
- Steel structure and helical disc ensure solidity
- For any type of terrain, resists freezing and thawing
- **CAN SUPPORT UP TO 5,000 LBS**

- Simple et efficace pour soutenir patio, remise ou galerie
- Pas de creusage ni de béton
- Substitut au tube de coffrage
- Solide - structure d'acier et disque hélicoïdal
- Pour tout type de terrain, résistant au gel et dégel
- **SUPPORTE JUSQU'À 5 000 LB**

**Do not use for fences /
Ne pas utiliser pour les clôtures**

**THE REGULAR PYLEX ALSO HAS A
PULLING FORCE OF 2,000 LBS THAT
KEEPS IT FIRMLY ANCHORED
IN THE GROUND**

**LE PYLEX RÉGULIER A AUSSI UNE
FORCE DE 2 000 LB CONTRE
L'ARRACHEMENT CE QUI
LE MAINTIEN SOLIDEMENT
ANCRÉ DANS LE SOL**

**Use with a dressed
4" x 4" post
Utiliser avec un
poteau de 4" x 4"**

Resists heaving
and sinking
Résiste à l'arrachement
et l'enfoncement



EASY INSTALLATION / INSTALLATION FACILE

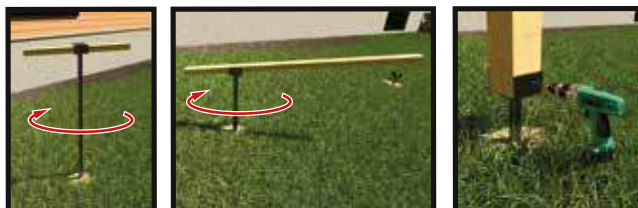

NAME / NOM

Pylex Regular 50" / Pylex régulier 50"

BLACK / NOIR

10505

QTY / QTÉ
masterpack / carton

64

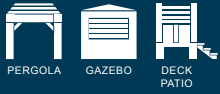

ADJUSTABLE PYLEX PYLEX AJUSTABLE

Screwable deck post anchor / Vis d'ancrage pour patio



STEEL ACIER

HELICAL PILE
VIS DE FONDATION

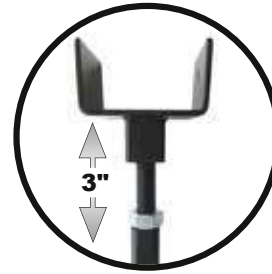

- Supports patio, balcony or shed pillars
- Resists to ground movements (frost, thaw)
- Adjustable head - up to 3" on height
- Compatible with 24" extensions to push the disk deeper below the frost line
- Substitute for concrete forms and cement
- For vertical charge

SUPPORTS UP TO

- 5,000 LBS IN SANDY GROUND
- 3,500 LBS IN CLAY GROUND
- RESISTS AGAINST SINKING

Do not use for fences

- Supporte les piliers de patio, galerie ou remise
- Résiste aux mouvements du sol (gel, dégel)
- Tête ajustable en hauteur de 3"
- Rallonge de 24" disponible pour enfoncement plus profond
- Substitut au tube de coffrage
- Pour charge verticale

SUPPORTE JUSQU'À

- 5000 LB DANS UN SOL SABLEUX
- 3500 LB DANS UN SOL ARGILEUX
- RÉSISTE À L'ENFONCEMENT

Ne pas utiliser pour les clôtures



32"



50"

AVAILABLE / DISPONIBLE



ADJUSTABLE PYLEX AND EXTENSION DISPLAY PRÉSENTOIR POUR PYLEX AJUSTABLE ET RALLONGE

MINIMUM ORDER COMMANDE MINIMUM

64 adjustable Pylex units (10555)
unités de Pylex ajustables (10555)

48 24" extension units (10571)
unités de rallonges 24" (10571)

39" x 25" x 82"
including poster
incluant l'affiche
Code Pylex
9103

Use with a dressed
4" x 4" in post

Utiliser avec un
poteau de 4" x 4"

Resists against sinking
Résiste à l'enfoncement

NAME / NOM

#

BLACK / NOIR

QTY / QTÉ
masterpack / carton

50" Adjustable Pylex / Ajustable

10555

64

32" Adjustable Pylex / Ajustable

10565

64

Display / Présentoir

9103

1

LATERAL STABILIZER
STABILISATEUR LATÉRAL



- Can be added to a Pylex helical pile to increase lateral support on a new or existing structure
- S'ajoute à une vis de fondation Pylex pour augmenter le support latéral sur une structure neuve ou déjà existante

EXTENSION RALLONGE **24"**



- Extends an adjustable Pylex by 24" to reach a more solid surface in the ground if necessary. Compatible with Pylex 32" and 50" adjustable helical piles
- Permet de rallonger de 24" un Pylex ajustable afin d'atteindre une surface plus solide dans le sol si nécessaire. Compatible avec les vis Pylex ajustables de 32" ou 50"

COMPATIBLE WITH: AVEC :
10505
10555
10565



COMPATIBLE WITH: AVEC :
10555
10565



NAME / NOM

Lateral Stabilizer / Stabilisateur latéral

24" Extension / Rallonge

BLACK / NOIR

10575

10571

QTY / QTÉ
masterpack / carton

16

12



PYLEX-L

For fences of 60" or less
Pour clôtures de 60" ou moins



STEEL ACIER

HELICAL PILE
VIS DE FONDATION



**Use with a dressed 4" x 4" post
Utiliser avec un poteau de 4" x 4"**

Resists heaving and sinking
Résiste à l'arrachement et l'enfoncement



- Increases lateral solidity
- Quick and easy assembly and installation
- Ensures stability - disc is under the 42" frost line
- For installations under 60" Designed for fences, small signs, mailboxes and others...
- **SUPPORTS UP TO 4,000 LBS**
- Accroît la solidité latérale
- Montage et installation rapide et facile
- Garantit une stabilité contre le soulèvement par le gel - le disque est à plus de 42" dans le sol
- Pour des installations de moins de 60" - clôtures, petites enseignes, boîte aux lettres, etc.
- **SUPPORTE JUSQU'À 4000 LB**



Blades ensure lateral stability
Can support up to 4,000 lbs

Aillettes pour assurer une stabilité latérale
Supporte jusqu'à 4000 lb

NAME / NOM

Pylex-L

BLACK / NOIR

10725

QTY / QTÉ
masterpack / carton

65



- Foundation and anchor screw for commercial shelters or patios, decks, sheds, fences, signs and mailboxes
- Resists ground movement
- Economical, durable and strong method

Supports up to

- 5,000 lbs of load
- 4,781 lbs of pulling force
- 1,641 lbs of lateral thrust, depending on the ground composition

- Vis de fondation et d'ancrage pour abris commerciaux, patios, galeries, remises, clôtures, enseignes, boîtes postales
- Résiste aux mouvements du sol
- Méthode économique, solide et durable

Supporte jusqu'à

- 5000 lb de charge
- 4781 lb de force d'arrachement
- 1641 lb de poussée latérale, selon la composition du sol



Use with a dressed
6" x 6" post

Utiliser avec un poteau de 6" x 6"



NAME / NOM

Commercial Pylex 66 / Pylex Commercial 66

BLACK / NOIR

10730

QTY / QTÉ

48



SPYTEK 22

Adjustable / Ajustable



ZINC PLATED STEEL
ACIER PLAQUÉ ZINC

FENCE
CLÔTURE

FOR ORNAMENTAL ALUMINUM OR STEEL FENCE

- Adjustable square head ground spike for 2" X 2" (up to 72" high) aluminum or steel posts
- Quick installation
- No need to dig or pour concrete
- Solidly anchored into the ground by the blades
- Four (4) bolts to adjust post level

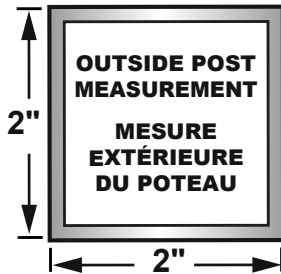

POUR CLÔTURE ORNEMENTALE EN ALUMINIUM OU ACIER

- Pieu à enfoncer à tête carrée ajustable pour poteau en aluminium ou en acier de 2" x 2" (jusqu'à 72" de haut)
- Rapide à installer
- Solidement ancré par les lames enfoncées au sol
- Pas besoin de creuser ou de couler le béton
- Quatre (4) boulons permettent d'ajuster le poteau au niveau



For square post / Pour poteau carré

Adjustment system to ensure the straightening of post

Système d'ajustement pour poteau au niveau



NAME / NOM

Spytek **22** adjustable / ajustable

ZINC PLATED STEEL
ACIER PLAQUÉ ZINC

13015

QTY / QTÉ
masterpack / carton

6



SPYTEK 112 / 178 / 238

Adjustable / Ajustable

ZINC PLATED STEEL
ACIER PLAQUÉ ZINC

FOR CHAIN LINK FENCING UP TO 72"

- Ground spike with adjustable head for round post
- Quick installation
- No need to dig or pour concrete
- Four (4) bolts to level the post

POUR CLÔTURE EN MAILLE DE CHAÎNE JUSQU'À 72" DE HAUT

- Pieu à enfoncer avec tête ajustable pour poteau rond
- Rapide à installer
- Pas besoin de creuser ou de couler du béton
- Quatre (4) boulons pour mettre le poteau au niveau

3 SIZES / ADJUSTABLE / FOR ROUND POSTS

3 DIMENSIONS / AJUSTABLE / POUR POTEAUX RONDS

- **SPYTEK 112** = 1-1/2" / 1-5/8"
- **SPYTEK 178** = 1-7/8"
- **SPYTEK 238** = 2-3/8"

Spytek Adjustable 178 may fit some square 2" x 2" aluminum posts.

Le Spytek Ajustable 178 peut convenir à certains poteaux carrés d'aluminium de 2" x 2".

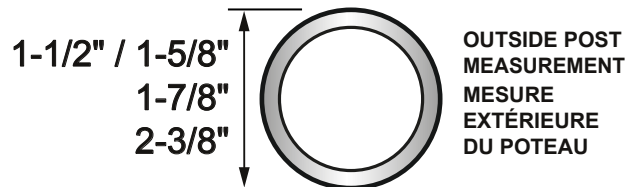

For round post / Pour poteau rond

Adjustment system to ensure the straightening of post

Système d'ajustement pour poteau au niveau



NAME / NOM

Spytek **112-158** adjustable / ajustable

Spytek **178** adjustable / ajustable

Spytek **238** adjustable / ajustable

ZINC PLATED STEEL
ACIER PLAQUÉ ZINC

13020

13021

13022

QTY / QTÉ
masterpack / carton

6

6

6



**SPYBASE
22**

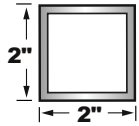

Outside post measurement
Mesure extérieure du poteau



**SPYBASE
112
158**

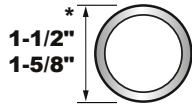

**SPYBASE
178**

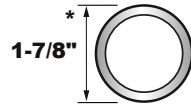

**SPYBASE
238**

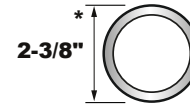

* Outside post measurement
Mesure extérieure du poteau

For square post /
Pour poteau carré

For round post
Pour poteau rond



IDEAL FOR FENCE : CHAIN LINK / ORNAMENTAL :
Anchoring device for posts less than 60" high, round or square, on concrete
IDÉAL POUR CLÔTURE : MAILLES DE CHAÎNE / ORNAMENTAL :
Dispositif d'ancrage pour poteau de moins de 60" de haut, rond ou carré sur le béton

NAME / NOM	ZINC PLATED STEEL ACIER PLAQUÉ ZINC	QTY / QTÉ masterpack / carton
Spybase 22	13076	6
Spybase 112-158	13077	6
Spybase 178	13078	6
Spybase 238	13079	6



No need to change
a broken post at
ground level
Nul besoin
de changer un
poteau cassé au
niveau du sol

NAME / NOM	BLACK / NOIR	QTY / QTÉ masterpack / carton
Post Repair Kit / Ensemble de réparation de poteau	14105	10

HEAVY-DUTY SLIDING GATE KIT

Quincaillerie de

PORTE COULISSANTE SUR RAIL



**GALVANIZED
STEEL
ACIER
GALVANISÉ**

**FENCE
CLÔTURE**

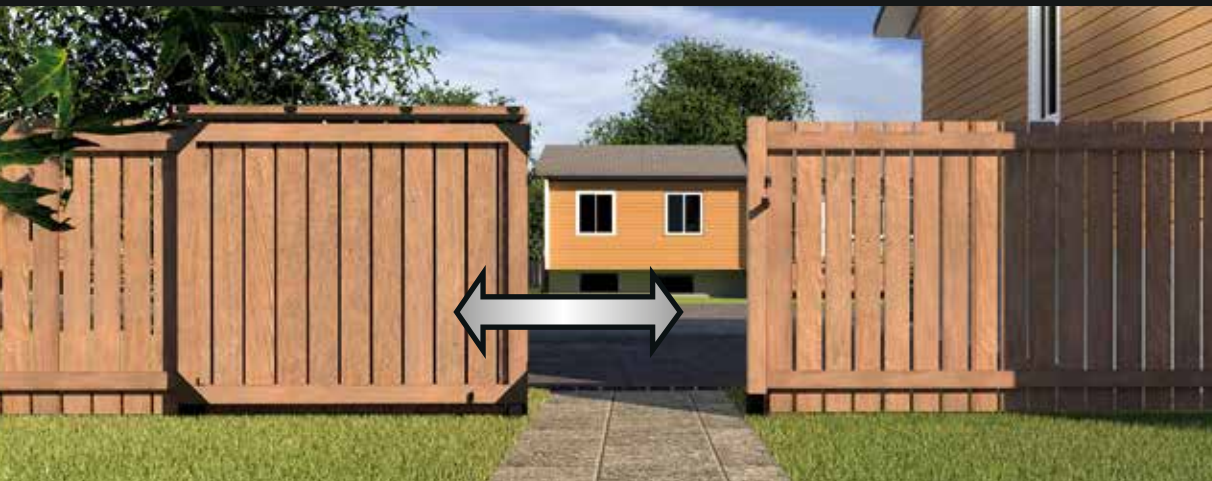

**REVERSIBLE
RÉVERSIBLE**

**Opens and
closes easily**

**S'ouvre et
se ferme
facilement**

Ball bearing system allowing the door to hang on a rail system. Slides easily.

Système de roulement à bille permettant à la porte de s'accrocher sur un système de rails. Roulement facile.

The pvc wheel with adjustable roller ensures proper clearance height from the ground for easy opening and closing action

La roue en pvc avec roulette réglable assure une hauteur de dégagement par rapport au sol pour une ouverture et fermeture facile

NAME / NOM

Heavy-Duty Sliding Gate Kit / Quincaillerie de porte coulissante sur rail

BLACK / NOIR

11057

QTY / QTÉ
masterpack / carton

3

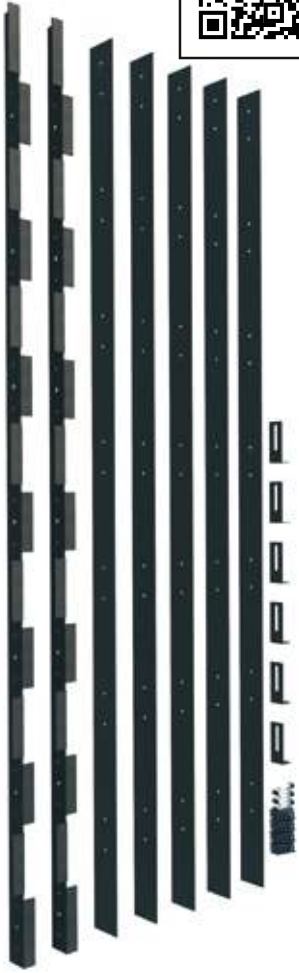

Vertical

**HARDWARE USED TO INSTALL
A FENCE**

- Easy, fast, straight, no calculations needed for even board distribution
- May be used with steel posts (sold separately)

**QUINCAILLERIE SERVANT À
INSTALLER UNE CLÔTURE**

- Facile, rapide, bien droite, aucun calcul nécessaire pour une distribution uniforme des planches
- Peut être utilisé avec des poteaux en acier (vendus séparément)



Horizontal

Contains
1 set to make
1 PANEL
MAX : 74"

Contient
1 ensemble
pour faire
1 PANNEAU
MAX : 74"

Privacy panel
Panneau intimité



NAME / NOM

Latitude System / Système Latitude

MATTE BLACK / NOIR MAT

13090

QTY / QTÉ
masterpack / carton

1



A

- The stabilizing anchor hook allows the post to return to its original position when the ground thaws.

- Crochet d'ancrage stabilisateur permettant au poteau de reprendre sa position initiale lors du dégel du sol.

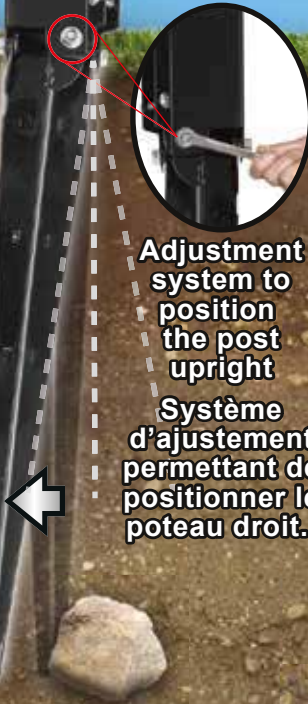

Adjustment system to position the post upright
Système d'ajustement permettant de positionner le poteau droit.



B



C



D



A

ADJUSTABLE SPYTEK 44:

- Ground spike with adjustable head for 4" x 4" square post
- Four bolts to level post
- **Use:** fence, max: 60", mail box and light sign

SPYTEK 44 – AJUSTABLE :

- Pieu à enfoncer avec tête ajustable pour poteau carré 4" x 4"
- Quatre boulons pour ajuster le poteau au niveau
- **Utilisation:** Clôture max : 60", boîte postale, enseigne légère

B

ECOSPIKE 44:

- Ground spike for 4" x 4" square post
- **Use:** fence, max: 60" mail box, sign

ECOSPIKE 44 :

- Pieu à enfoncer pour poteau carré 4" x 4"
- **Utilisation:** Clôture max : 60" boîte postale, enseigne

C

ECOSPIKE 2:

- Ground spike for 4" x 4" square
- **Use:** Decorative fence, max: 36", small sign, mail box and birdhouse

ECOSPIKE 2 :

- Pieu à enfoncer pour poteau carré 4" x 4"
- **Utilisation:** Clôture max : 36", petite enseigne, boîte postale, cabane d'oiseau

D

HEAVY-DUTY SPIKE 44/66:

- Ground spike for 4" x 4" or 6" x 6" square post
- Sturdy and economical
- **Use:** fence, max: 84", mail box and sign

PIEU ROBUSTE 44/66 :

- Pieu à enfoncer pour poteau carré 4" x 4" ou 6" x 6"
- Rigide et économique
- **Utilisation:** Clôture max : 84", boîte postale, enseigne

NAME / NOM

BLACK / NOIR

QTY / QTÉ
masterpack / carton

A Spytek 44 Adjustable / Spytek 44 Ajustable

13002

80

B Ecospike 44

13013 / 13014

6 / 160

C Ecospike 2

13012

160

D Heavy-Duty Spike 44 / Pieu Robuste 44

12987

4

D Heavy-Duty Spike 66 / Pieu Robuste 66

12988

2



36



ADJUSTABLE SUPPORT designed to solidly support your deck.

- A reliable and efficient solution!
- Facilites floor leveling during construction or its adjustment following ground movement (freezing, thawing)
- Steel structure for strength and durability
- It can be simply installed on a support block or concrete column
- Completely reversible: tip the base 180 degrees
- No maintenance
- **SUPPORTS UP TO 2,725 LBS**

SUPPORT AJUSTABLE conçu pour soutenir solidement votre patio.

- Solution fiable et performante!
- Facilite la mise au niveau du plancher durant sa construction ou son réajustement à la suite des mouvements du sol (gel, dégel)
- Structure en acier procurant solidité et grande résistance
- S'installe simplement sur un bloc de soutien ou une colonne de béton
- Complètement réversible: faites basculer la base de 180 degrés
- Ne nécessite aucun entretien
- **SUPPORTE JUSQU'À 2725 LB**



44C



All Deck Supports are
REVERSIBLE
Tous les Supports de patio sont
RÉVERSIBLES



44
66



**ALL DECK SUPPORTS
ARE ADJUSTABLE**

**TOUS LES SUPPORTS DE
PATIO SONT AJUSTABLES**



33/66



Can be adjusted to the required width
Permet d'ajuster le support de
plate-forme à la largeur requise

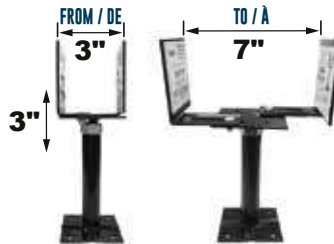

NAME / NOM

BLACK / NOIR

QTY / QTÉ
masterpack / carton

36 Adjustable Deck Support 36 / Support de patio ajustable 36

12095

12

44C Adjustable Deck Support 44C / Support de patio ajustable 44C

12096

12

66 Adjustable Deck Support 66 / Support de patio ajustable 66

12097

12

33/66 Adjustable Deck Support Extensible 33-66 / Support de patio ajustable et extensible 33/66

12098

12

44 Adjustable Deck Support 44 / Support de patio ajustable 44

12099

12



DECK TRACK BANDE DE FIXATION POUR PATIO



**STEEL
ACIER**

**DECK
PATIO**



DECK TRACK QUANTITY GUIDE / NOMBRE DE BANDES

Total deck square footage Nombre de pieds carrés total du patio	Joist spacing / Espacement des solives					
	C/C 16 in / po O.C.			C/C 24 in / po O.C.		
	TRACK BANDE	SCREWS VIS	NAILS CLOUS	TRACK BANDE	SCREWS VIS	NAILS CLOUS
32 sq. ft. / pi.ca.	7	168	56	5	120	40
100 sq. ft. / pi.ca.	24	576	192	16	384	128
144 sq. ft. / pi.ca.	32	768	256	22	528	176
192 sq. ft. / pi.ca.	41	984	328	29	696	232
256 sq. ft. / pi.ca.	55	1320	440	38	912	304

Based on Deck Track covering 4.57 sq. ft. / Calculer qu'une bande couvre 4.57 pi.ca.

SCREWS / VIS #10 x 7/8" 300 PCS / MCX



12114

DECK TRACK KIT ENSEMBLE DE BANDES DE FIXATION

KIT INCLUDES :
ENSEMBLE COMPREND :
14 x 22-1/2" deck track / bande fixation
170 x 7/8" screws / vis
58 x 2" nails / clous

Includes all hardware for
32 sq.ft.

Toute la quincaillerie
incluse pour
32 pi.ca.



12117

NAME / NOM

BLACK / NOIR

QTY / QTÉ
masterpack / carton

45" Deck Track / Bande de fixation pour patio 45"

12118

20

32 sq.ft. Deck Track Kit / Ensemble de bandes de fixation pour patio – 32 pi.ca.

12117

6

#10 x 7/8" Deck Track Screws (300 pcs) / Vis #10 x 7/8" pour bande de fixation (300 pcs)

12114

12 x 300

**TAR PAPER
PAPIER
GOUDRONNÉ**



**JOIST WATERPROOF STRIP
BANDE IMPERMÉABLE POUR SOLIVE**



For simple joist
Pour solive simple

3"



For double joist
Pour solive double

4-1/2"



Unroll and staple
the waterproof
strip to joist

Dérouler etagrafer la
bande imperméable
sur la solive

Length : **72'**
Longueur :



- Professional technique
- Waterproof protection to prevent each joist from rotting
- Technique professionnelle
- Protection imperméable empêchant la pourriture sur chaque solive



NAME / NOM

BLACK / NOIR

QTY / QTÉ
masterpack / carton

Joist Waterproof Strip
Bande Imperméable pour solive **72' X 3"**

12090

16

Joist Waterproof Strip
Bande Imperméable pour solive **72' X 4-1/2"**

12091

12

**STEEL
ACIER**



J-FIX

"J" shaped fixing clamp to attach the deck structure
to the house wall
Étrier de fixation en «J» pour fixer structure d'un
patio/galerie au mur de la maison.



- No need to remove exterior siding
- Good ventilation to prevent water accumulation and rotting of the frame
- Simplifies the attachment of the patio to the wall of the house
- Prevents water infiltration
- Pas besoin d'enlever le revêtement extérieur
- Bonne aération prévenant l'accumulation d'eau et la pourriture de la charpente
- Simplifie la fixation du patio au mur de la maison
- Prévient l'infiltration d'eau

LAG SCREW / VIS TIREFOND : 4-1/2"

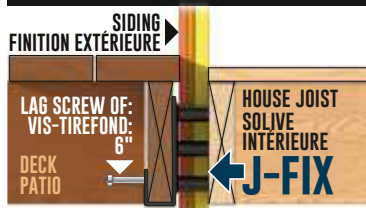

NAME / NOM

BLACK / NOIR

QTY / QTÉ
masterpack / carton

J-Fix

12110

12

SELF-LEVELING LATCH LOQUET AUTONIVELANT



**STEEL
ACIER**

**DECK
PATIO**

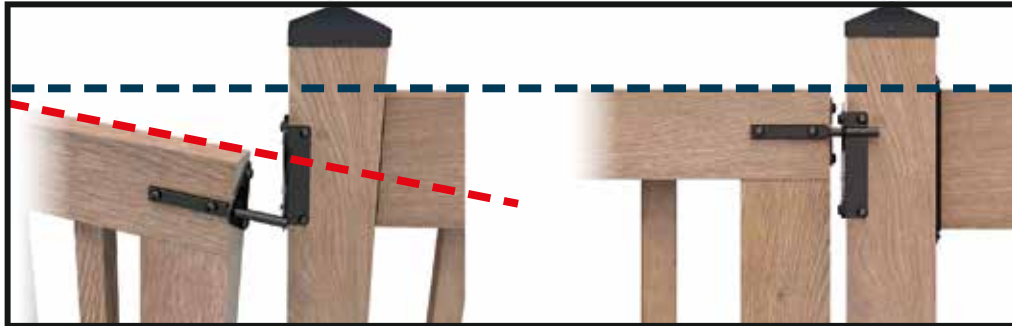

Repositions and keeps the door level / Repositionne et maintient la porte au niveau

RELIABLE AND EFFICIENT QUALITY LATCH

- Offers a lateral mechanism that keeps the gate door level and supports its weight when closed
- Designed for inward or outward opening doors and gates
- Latches automatically and easily
- Can be locked with a padlock

LOQUET FIABLE, PERFORMANT ET DE QUALITÉ

- Mécanisme de fixation latéral maintenant la barrière au niveau et soutenant son poids lorsque fermée
- Conçu pour portes et barrières s'ouvrant vers l'intérieur ou l'extérieur
- Se bloque automatiquement et facilement
- Peut se verrouiller avec un cadenas



**Supports the
weight of the
gate when closed**

**Supporte le poids
de la barrière
lorsque fermée**

NAME / NOM

Self-Leveling Latch / Loquet autonivelant

BLACK / NOIR

11055

QTY / QTÉ
masterpack / carton

10



SPYTEKDECK Adjustable / Ajustable



**STEEL
ACIER**

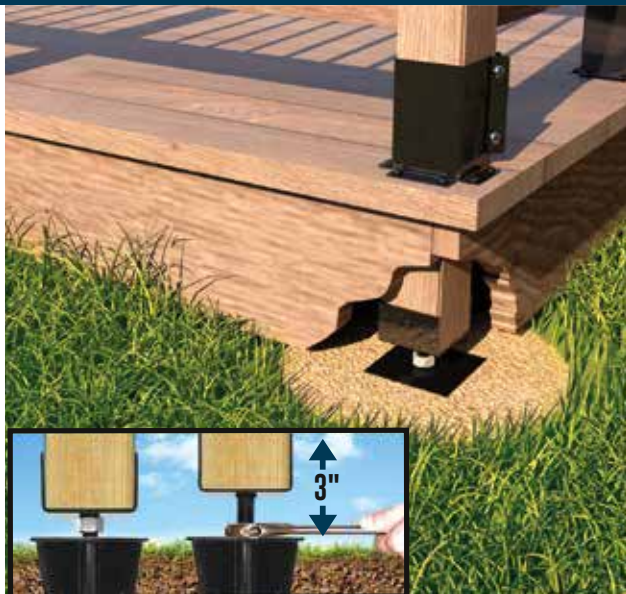

Stabilizing anchor hook system

- Allows the post to return to its initial position when the ground thaws
- Design to replace "Deck Blocks"
- Can support shed, deck or porch
- Adjusts up to 3" height
- Facilitates installation and leveling

Crochet d'ancrage stabilisateur

- Permet au poteau de reprendre sa position initiale lors du dégel du sol
- Conçu pour remplacer un «Deck Block»
- Pour cabanon, galerie, patio, remise
- S'ajuste jusqu'à 3" sur la hauteur
- Facilite l'installation et la mise au niveau



**Use with a dressed
4" x 4" post**

**Utiliser avec un
poteau de 4" x 4"**

NAME / NOM

Spytekdeck

BLACK / NOIR

13003

QTY / QTÉ
masterpack / carton

48



**SIMPLE OR
HEAVY-DUTY**

- Prevents the gate frame from warping
- For an opening up to 72" wide
- Left or right opening
- Use with 2" x 4" or 2" x 3"

**SIMPLE OU
ULTRA ROBUSTE**

- Empêche le cadre de la barrière de se déformer
- Pour une ouverture jusqu'à 72" de large
- Ouverture à gauche ou à droite
- Utiliser avec 2" x 4" ou 2" x 3"

**HEAVY-DUTY
ULTRA ROBUSTE**



50% thicker hinges
Pentures 50% plus épaisses

NAME / NOM

Gate Kit / Quincaillerie pour barrière

Heavy-Duty Gate Kit / Quincaillerie pour barrière Ultra Robuste

BLACK / NOIR

11050

11051

QTY / QTÉ
masterpack / carton

5

5

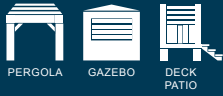

SLIDING GATE KIT

Quincaillerie de
BARRIÈRE COULISSANTE



**STEEL
ACIER**

**DECK
PATIO**



Ngcs contracting



Staveness Studios



Benjamin Badeau



Jordan Fry Taylor

- INCLUDED :**
- Brackets
 - Wheels
 - Latch

- INCLUS :**
- Équerres
 - Roulettes
 - Loquet

Balusters not included
Barreaux non-inclus

**SEVERAL FINISHES CAN BE MADE
ACCORDING TO YOUR NEEDS
S'ADAPTE SUR DIFFÉRENTES
FINITIONS DE BARRIÈRE**



Boards /
Planches



Wood
balusters /
Barreaux
de bois



Aluminum
balusters /
Barreaux en
aluminium

- Perfect for tight spaces
- Latch system
- Can be locked with a padlock
- Easy opening

- Parfait pour les espaces restreints
- Système de verrouillage
- Peut être verrouillé avec un cadenas
- Ouverture facile

- Max height : 60"
- Recommended max length : 72"
- Hauteur max : 60"
- Largeur maximale recommandée : 72"

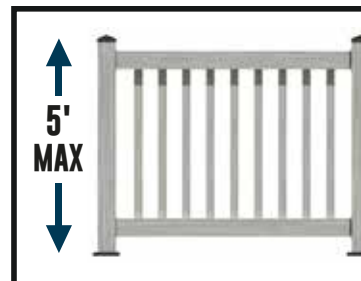

NAME / NOM

Sliding gate kit / Quincaillerie de barrière coulissante

BLACK / NOIR

11052

QTY / QTÉ
masterpack / carton

5



Simple and well designed!
The bracket that brings peace of mind by supporting the full load of your deck
Even in case of excessive weight, your deck will maintain its original appearance

- Steel construction → great resistance and strength
- All the load is absorbed by the W-shaped bracket that holds the beam firmly in place, unlike traditional methods (wood screws)

Simple et bien pensé!
L'étrier qui apporte la paix d'esprit en supportant toute la charge de votre patio
Même en cas de surplus de poids, votre patio conservera son apparence initiale

- Fabrication en acier → une grande résistance et solidité
- Toute la charge est absorbée par l'étrier en forme de «W» qui maintien la poutre solidement en place, contrairement aux méthodes traditionnelles (vis à bois)

1 Place Suplak on dressed 4" x 4" post
Mettre la Suplak sur un poteau carré de 4" x 4"



2 The entire load rests on the Suplak
Toute la charge repose sur la Suplak

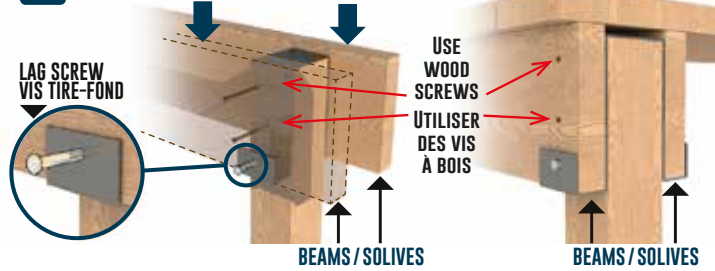

NAME / NOM
Suplak 44

BLACK / NOIR
12100

QTY / QTÉ
masterpack / carton
25



CONCRETE ANCHOR
ANCRAGE À BÉTON

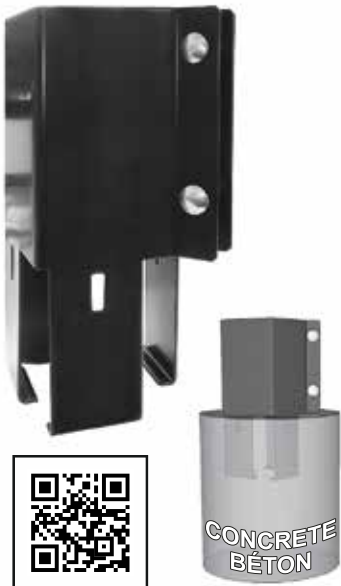

- Steel base designed to securely fix a square post in fresh concrete
- The concrete anchor is easy to install and economical
- Insert the post and insert the footing prongs in fresh concrete and let it dry
- Reliable and efficient solution
- Maintenance-free
- Base en acier conçue pour fixer solidement un poteau carré dans du béton frais
- L'ancrage à béton est facile d'installation et économique
- Insérer le poteau et enfoncer les dents du pied dans le béton frais et laisser sécher
- Solution fiable et performante
- Sans entretien

CONCRETE "U" SADDLE
SUPPORT EN « U » POUR BÉTON



- Simply place the saddle footing in fresh concrete and let dry for strength
- Maintenance-free
- Simplement enfoncer le pied du support dans le béton frais et laisser sécher pour la solidité
- Sans entretien

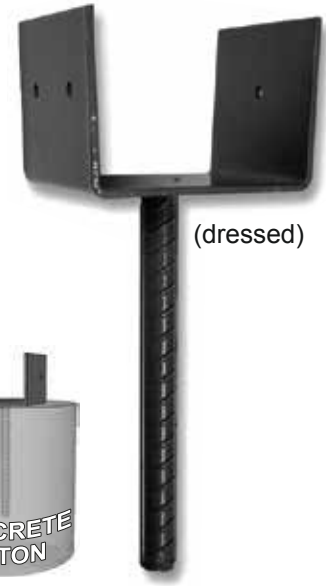

NAME / NOM
44 Concrete Anchor / Ancre à béton
66 Concrete Anchor / Ancre à béton

BLACK NOIR
13063 12
13064 4

NAME / NOM
44 Concrete U Saddle / Support en «U» pour béton
66 Concrete U Saddle / Support en «U» pour béton

BLACK NOIR
12840 16
12841 6



FIXRAIL
Rail connector
Connecteur de traverse



**GALVANIZED
STEEL
ACIER
GALVANISÉ**

**DECK
PATIO**



- Connector to securely attach a rail to a post
- Facilites the construction of your project
- Durable solution
- Contemporary look
- Use with 2" x 4" in rails
- Connecteur de traverse qui permet de fixer solidement une traverse à un poteau
- Facilite la construction de votre projet
- Solution résistante
- Look contemporain
- Pour traverses de 2" x 4"

Economical and sturdy
4 connectors per kit

Économique et robuste
4 connecteurs par boîte

NAME / NOM
FIXRAIL

MATTE BLACK / NOIR MAT
11090

QTY / QTÉ
masterpack / carton
20



FIXPLAK 23 / 24 / 24H / 26
Steel connector plate / Connecteur en acier



**STEEL / ACIER
+STAINLESS STEEL
ACIER INOXYDABLE**

**FACILITATES THE
CONSTRUCTION OF
YOUR PATIO OR DECK**
**FACILITE LA CONSTRUCTION
DE VOTRE PATIO OU GALERIE**



* **CORROSION
RESISTANT-
ANTICORROSION**

* **COATED WITH A BAKED-ON POWDER PAINT
ENDUIT D'UNE
PEINTURE EN POUDRE CUITE**



NAME / NOM	* KHAKI KAKI	* WHITE BLANC	* CEDAR CÉDRE	* BLACK NOIR	* STAINLESS STEEL ACIER INOXYDABLE	QTY / QTÉ masterpack / carton
Fixplak 23	10980	10990	11000	11008	11009	100
Fixplak 24	10955	10965	10975	10978	10979	100
Fixplak 26	10900	10910	10920	10930	10940	100
Fixplak 24H	12040	12045	12050	12055	----	100

**STEEL
ACIER**
+ STAINLESS STEEL
ACIER INOXYDABLE



FIXPLAK 44 / 66
Base plate / Plaque d'assise

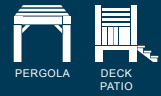

Use with a dressed
4" x 4" or 6" x 6" post
Utiliser avec un poteau
de 4" x 4" ou 6" x 6"



* COATED WITH A BAKED-ON POWDER PAINT
ENDUIT D'UNE
PEINTURE EN POUDRE CUITE

* CORROSION
RESISTANT
ANTICORROSION

NAME / NOM	* KHAKE KAKI	* WHITE BLANC	* CEDAR CEDRE	* BLACK NOIR	STAINLESS STEEL * ACIER INOXYDABLE	QTY / QTÉ masterpack / carton
Fixplak 44	10800	10810	10820	10830	10840	100
Fixplak 66	11010	11020	11030	11040	11045	50

PVC



PLAKCAP 44
(PVC) Plastic base cover
Cache-base en plastique (PVC)

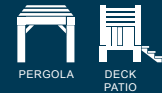

Use with a dressed
4" x 4" post
Utiliser avec un
poteau de 4" x 4"

- Plastic base to cover the Fixplak 44
- Adds a finishing touch to your deck
- Maintenance-free → made of PVC
- Easy installation (even once the post is installed) → two-part clip system

- Cache base en plastique pour recouvrir la Fixplak 44
- Ajoute une touche de finition au patio
- Fabrication en PVC → Aucun entretien requis
- Installation facile (même une fois le poteau installé) → deux pièces qui se fixent l'une à l'autre.

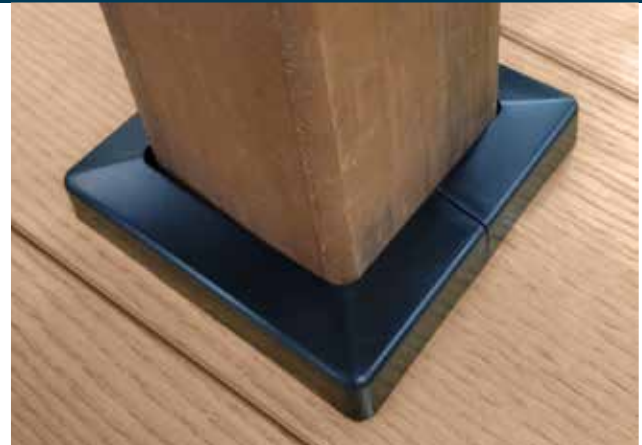

NAME / NOM	KHAKE KAKI	WHITE BLANC	CEDAR CEDRE	BLACK NOIR	QTY / QTÉ masterpack / carton
Plakcap 44	12000	12005	12010	12012	48



CAP 44 / 66



**STEEL
ACIER**
+ STAINLESS STEEL
ACIER INOXYDABLE

**DECK
PATIO**



- Decorative element
- Hides imperfections
- Protects against bad weather
- Resistant and solid

- Élément décoratif
- Cache les imperfections
- Protège des intempéries
- Résistant et solide



**Use with a dressed
4" x 4" post**
**Utiliser avec un
poteau de 4" x 4"**



* COATED WITH A BAKED-ON POWDER PAINT
ENDUIT D'UNE
PEINTURE EN POUDRE CUITE

* CORROSION-
RESISTANT
ANTICORROSION

NAME / NOM	* KHAKI KAKI	* WHITE BLANC	* CEDAR CÉDRE	* BLACK NOIR	STAINLESS STEEL * ACIER INOXYDABLE	QTY / QTÉ masterpack / carton
Cap 44	12025	12030	12035	12038	12039	48
Cap 66	12020	----	----	12023	----	48



BASE 44



STEEL / ACIER
+ STAINLESS STEEL
ACIER INOXYDABLE



- Style at low cost!
- Use with Fixplak 44
 - Easy installation: screw to floor then on the post
 - Securely attaches a square post to an exterior cement or wood surface
 - Adds a finishing touch to the patio
 - Stable and resistant
 - Maintenance-free

- Du style à peu de frais!
- Utiliser avec Fixplak 44
 - Installation facile : on la visse au plancher, puis au poteau
 - Fixe solidement des poteaux carrés sur une surface extérieure de ciment ou de bois.
 - Ajoute une touche de finition au patio
 - Résistant et solide
 - Sans entretien



**Use with a dressed
4" x 4" post**
**Utiliser avec un
poteau de 4" x 4"**



* COATED WITH A BAKED-ON POWDER PAINT
ENDUIT D'UNE
PEINTURE EN POUDRE CUITE

* CORROSION-
RESISTANT
ANTICORROSION

NAME / NOM	* KHAKI KAKI	* WHITE BLANC	* CEDAR CÉDRE	* BLACK NOIR	STAINLESS STEEL * ACIER INOXYDABLE	QTY / QTÉ masterpack / carton
Base 44	13045	13046	13047	13048	13049	25

STEEL
ACIER



FIXBASE 44

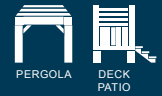

Use with a dressed
4" x 4" post
Utiliser avec un
poteau de 4" x 4"

Steel base designed to securely
fix a 4" x 4" dressed square post
to an exterior surface

- Economical and easy to install

Easy installation: Simply screw
the base to the floor and tighten
the collar.

Base en acier conçue pour fixer
solidement un poteau 4" x 4" carré
sur une surface extérieure

- Économique et facile à installer

Installation facile : Simplement
visser la base au sol et serrer le
collet

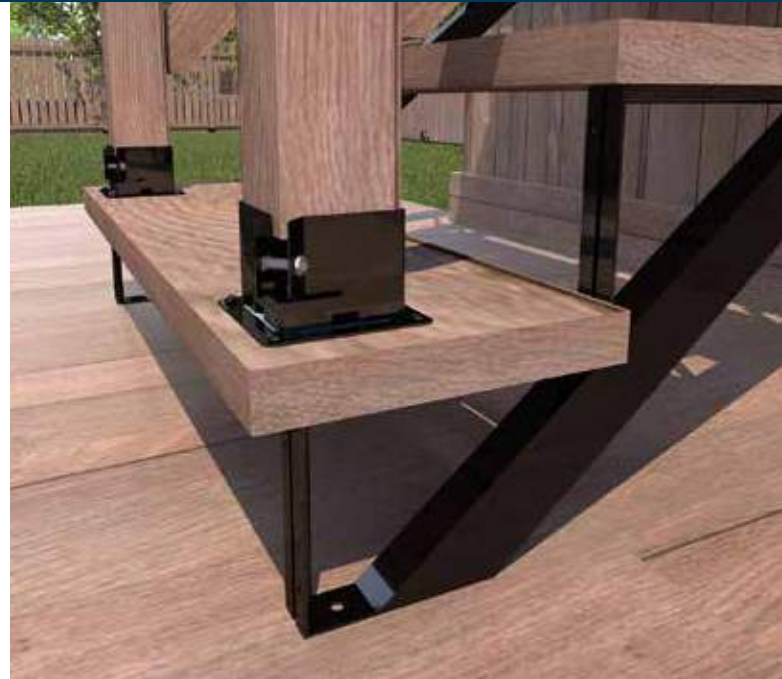
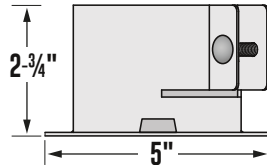

NAME / NOM
Fixbase 44

KHAKI / KAKI
13042

BLACK / NOIR
13062

QTY / QTÉ
masterpack / carton
20

STEEL
ACIER



BOLT DOWN
BASE DE FIXATION 44/66



Use with a dressed
4" x 4" or 6" x 6" post
Utiliser avec un
poteau de 4" x 4"
ou 6" x 6"

Designed to solidly attach a square
post to an exterior surface

- For stability and style at a low cost!
- Enables you to add a finishing
touch to your deck
- Maintenance-free

Easy installation: Simply screw
the base to the floor and tighten the
collar.

Conçu pour fixer solidement un poteau
carré sur une surface extérieure.

- De la solidité et du style à peu de frais!
- Ajoute une touche de finition à
votre patio.
- Sans entretien.

Installation facile : Simplement visser
la base au sol et serrer le collet

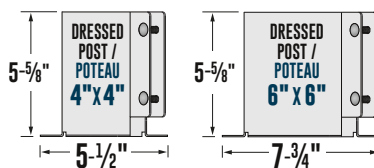

© Dock Industries Lатуque

NAME / NOM
44 Bolt Down / Base de fixation
66 Bolt Down / Base de fixation

KHAKI / KAKI
13040
13041

BLACK / NOIR
13060
13061

QTY / QTÉ
masterpack / carton

12
4



FENCE
CLÔTURE



PERGOLA



GAZEBO



DECK
PATIO

DECK SUNBLIND SYSTEM SYSTÈME DE STORE POUR PATIO



**STEEL
ACIER**
+ STAINLESS STEEL
ACIER INOXYDABLE

**DECK
PATIO**



Robin Feldberg



- Ideal for decks, gazebos and fences.
- Simple and easy installation.
- Idéal pour patio, gazébo et clôture.
- Installation simple et facile.

**BLACK
NOIR**

Steel
Acier



Stéphane Morin



Marc Lalancette

**STAINLESS STEEL
ACIER INOXYDABLE**

Corrosion
resistant
Anticorrosion



Robert Custom Builders

- Screws and brackets
- Max height : 49" (11 boards)
- Max width : 72"
- Vis et supports
- Hauteur max : 49" (11 planches)
- Largeur max : 72"

Wood not included
Bois non-inclus

NAME / NOM

Deck Sunblind System / Système de store pour patio

BLACK / NOIR

11060

**STAINLESS STEEL
ACIER INOXYDABLE**

11070

QTY / QTÉ
masterpack / carton

10



Use with a dressed
4" x 4" or 6" x 6" post

Utiliser avec un poteau
de 4" x 4" ou 6" x 6"



**MAXIMIZES
FLOOR SPACE
MAXIMISE
L'ESPACE PLANCHER**

NAME / NOM

Outaboundz Bracket / Étrier Horslimits

MATTE BLACK / NOIR MAT

13070

QTY / QTÉ
masterpack / carton

8



DECK STORAGE DRAWER TIROIR DE RANGEMENT POUR PATIO



**GALVANIZED
STEEL
ACIER
GALVANISÉ**

**DECK
PATIO**



Deck Phenom



- Allows efficient use of available space under the deck
 - Easy to open and close due to the ball-bearing slide tracks and handle (lockable)
 - Can be harmonized with any deck style and siding
 - Easy to install
 - Includes all necessary hardware to build a storage drawer (screws, fixing, tracks, PVC membrane, handle & key)
- Permet d'utiliser efficacement l'espace disponible sous le patio
- Facile à ouvrir et fermer grâce aux rails et à la poignée (verrouillable)
 - Peut être harmonisé avec tout style de patio et revêtement
 - Facile à installer
 - Inclut toute la quincaillerie nécessaire pour construire un tiroir de rangement (Vis, fixations, rails, membrane en PVC, poignée et clé)

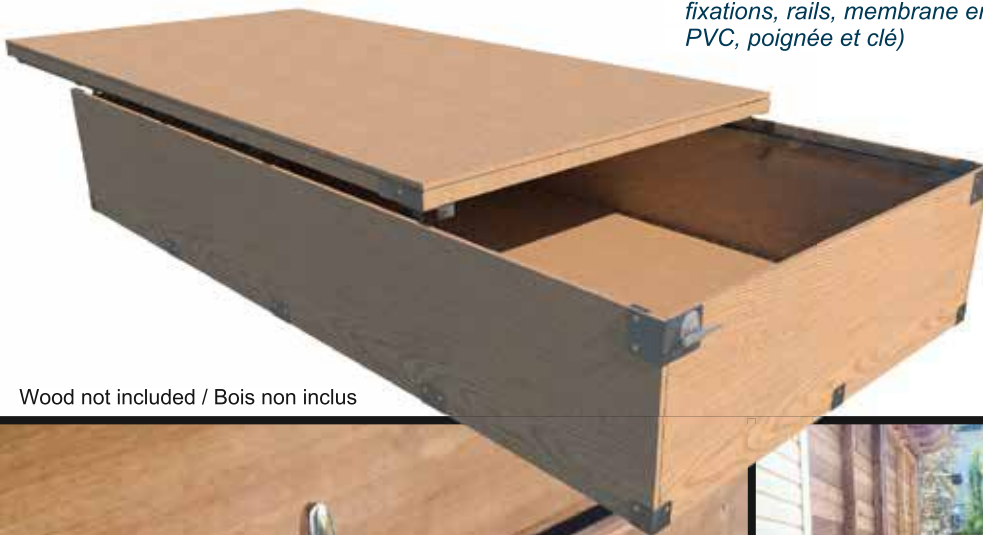

Wood not included / Bois non inclus



Robert Custom Builders

- Up to 250 lbs of load
- Lock handle for greater security
- Jusqu'à 250 lb de charge
- Se ferme avec une poignée avec clé pour plus de sécurité

NAME / NOM

#

**GALVANIZED
GALVANISÉ**

QTY / QTÉ
masterpack / carton

Deck Storage Drawer / Tiroir de rangement pour patio

12080

1

Display / Présentoir

9101

1

**STEEL
ACIER**



**UNIVERSAL STAIR STRINGER
LIMON UNIVERSEL**

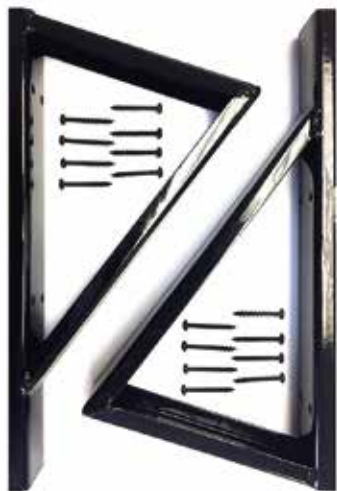

Use with dressed 2" x 4" - 2" x 6" - 2" x 8" or 2" x 10"

Included:

- 2 brackets
- Screws for step installation
- Simple and easy installation

Support d'acier se fixant à un :
2" x 4" - 2" x 6" - 2" x 8"
ou 2" x 10"

Inclus :

- 2 supports
- Vis pour installation de la marche
- Simple et facile d'installation



NAME / NOM

Universal Stair Stringer / Limon universel

BLACK / NOIR

14201

QTY / QTÉ
masterpack / carton

10



**STAIR FASTENING STRIP
BANDE DE FIXATION POUR LIMON**

STEEL / ACIER



- Perforated steel strip band made to secure and support stair stringers on deck frame
- Bande d'acier perforée pour fixer et soutenir les limons d'escalier sur les charpentes



**NAME
NOM**

Stair Fastening Strip / Bande de fixation

**BLACK
NOIR**

13120

QTY / QTÉ
masterpack / carton

50

**ADJUSTABLE STAIR BRACKET
SYSTÈME DE LIMON AJUSTABLE**



GALVANIZED STEEL / ACIER GALVANISÉ

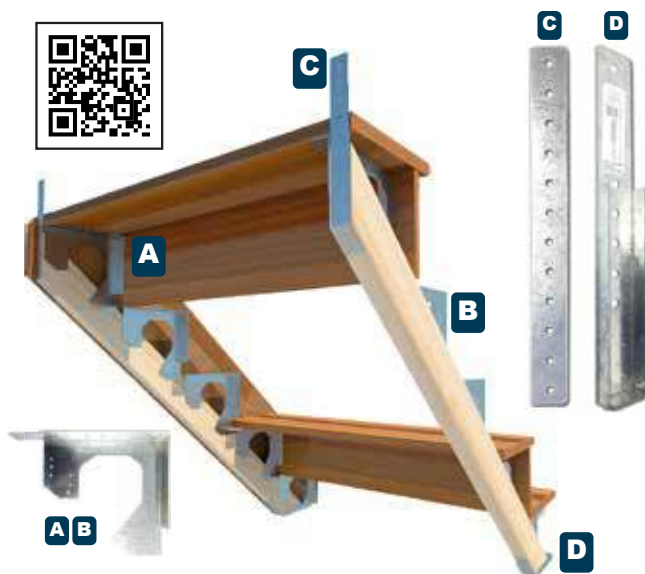

**NAME
NOM**

A Stair Stringer Left / Limon ajustable gauche

B Stair Stringer Right / Limon ajustable droit

C Stair Fastening Strip / Bande de fixation

D Stair Base / Patin pour limon

**GALVANIZED
GALVANISÉ**

QTY / QTÉ
masterpack / carton

13165

13170

13180

13175

50

50

50

50



STAIR TREAD MARCHE



STEEL ACIER

STAIR STRINGERS
& STAIR TREADS /
LIMONS ET MARCHES

36"

42"

48"

60"

72"

Widths / Largeurs



Compatible with
stair stringers : **13901**
TO / À
Compatible avec
les limons : **13907**
(p. 35)



**NEW
NOUVEAU**



Bolts
included
Boulons inclus



- **Maintenance-free**
- **Available in 5 widths**
- **Sans entretien**
- **Disponible en 5 largeurs**

Nonslip
Antidérapant

NAME / NOM

**BLACK
NOIR**

QTY / QTÉ
masterpack / carton

36" Steel Stair Tread / Marche en acier

13941

1

42" Steel Stair Tread / Marche en acier

13942

1

48" Steel Stair Tread / Marche en acier

13943

1

60" Steel Stair Tread / Marche en acier

13944

1

72" Steel Stair Tread / Marche en acier

13945

1



**NEW
 NOUVEAU**



**For a unique, clean
 and modern decor
 Pour un décor unique,
 épuré et moderne**



Always requires
 3 Pylex stringers,
 not included
 Nécessite toujours
 3 limons Pylex,
 non inclus

# STEPS MARCHES	HEIGHT HAUTEUR	Number of stringers Nombre de limons	Number of central stringer systems Nombre de systèmes pour limon central
1	15"	3 x 13901	2
2	22-1/2"	3 x 13902	3
3	30"	3 x 13903	4
4	37-1/2"	3 x 13904	5
5	45"	3 x 13905	6
6	52-1/2"	3 x 13906	7
7	60"	3 x 13907	8

NAME / NOM
 Central Steel Stringer System / Système pour limon central acier

BLACK / NOIR
 13925

QTY / QTÉ
 masterpack / carton
 1



STAIR STRINGERS LIMONS



STEEL ACIER

STAIR STRINGERS
& STAIR TREADS /
LIMONS ET MARCHES



Mike Rider

1 to 7 steps
1 à 7 marches



# STEPS MARCHES	HEIGHT STRUCTURE HAUTEUR
1	15"
2	22-1/2"
3	30"
4	37-1/2"
5	45"
6	52-1/2"
7	60"

STEPS MARCHES	BEAM / POUTRE
	SIZE
1 - 2 - 3	1-1/2" x 1-1/2"
4 - 5	1-1/2" x 2-3/8"
6 - 7	1-1/2" x 3-1/8"

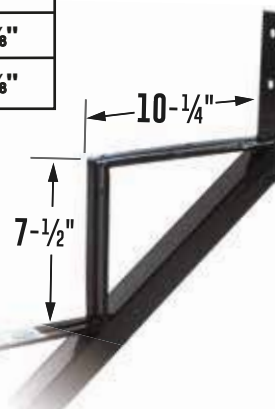

- Steel tubing provides long-lasting stability and increases product life
- Easy and fast installation
- Tube en acier qui offre plus de durabilité et de stabilité pour une durée de vie prolongée
- S'installe facilement et rapidement

NAME / NOM

BLACK / NOIR

QTY / QTÉ
masterpack / carton

Steel Stair Stringer 1 – Step / Limon en acier – 1 marche	13901	4
Steel Stair Stringer 2 – Steps / Limon en acier – 2 marches	13902	4
Steel Stair Stringer 3 – Steps / Limon en acier – 3 marches	13903	4
Steel Stair Stringer 4 – Steps / Limon en acier – 4 marches	13904	2
Steel Stair Stringer 5 – Steps / Limon en acier – 5 marches	13905	2
Steel Stair Stringer 6 – Steps / Limon en acier – 6 marches	13906	2
Steel Stair Stringer 7 – Steps / Limon en acier – 7 marches	13907	2

**STEEL
ACIER**



**STEEL STRINGER CONNECTOR
CONNECTEUR POUR LIMON ACIER**



Compatible only with
Pylex stair stringers :

Compatible seulement avec
les limons Pylex :

**13904 - 13905
13906 - 13907**



Sturdy and safe

Economical solution for
connecting 2 steel stringers
to create an 8-14-steps
stringer

Solide et sécuritaire

Solution économique pour
réunir 2 limons en acier
pour former un limon
de 8 à 14 marches

IMPORTANT



**USE WITH 2
DRESSED POST /
UTILISER AVEC 2
POTEAUX CARRÉS**
4" X 4"

**RECOMMENDED
RECOMMANDÉ
reinforcement :
renfort :
2" X 4"**

MATERIALS REQUIRED / MATÉRIAUX REQUIS

Height of the support post may vary depending
on the unevenness of the ground
Hauteur du poteau de soutien peut varier
selon la dénivellation du terrain

# OF STEPS # MARCHES	STAIR STRINGERS LIMONS	POST HEIGHT HAUTEUR DU POTEAU
8	13904 + 13904	31"
9	13905 + 13904	38"
10	13905 + 13905	
11	13906 + 13905	48"
12	13906 + 13906	
13	13907 + 13906	54"
14	13907 + 13907	

NAME / NOM

Steel Stringer Connector / Connecteur pour limon acier

BLACK / NOIR

13920

QTY / QTÉ
masterpack / carton

6



STAIR TREAD MARCHE 9-3/4"



**ALUMINUM
ALUMINIUM**

STAIR STRINGERS
& STAIR TREADS /
LIMONS ET MARCHES

36" 42" 48" 60"

Widths / Largeurs

Collection **10**

Compatible with
stair stringers : **9-1/16"**

Compatible avec
les limons : **9-1/16"**



Stainless
steel bolts
included
Boulons en
acier inoxydable
inclus

- **Maintenance-free**
- **Available in 4 widths and 3 colors**
- **Sans entretien**
- **Disponible en 4 largeurs et 3 couleurs**

Nonslip / Antidérapant



NAME / NOM

**WHITE
BLANC**

**BLACK
NOIR**

**ANODIZED
ANODISÉ**

QTY / QTÉ
masterpack / carton

Coll.10 – 36" Aluminum Stair Treads / Marche en aluminium

14136

14141

14146

1

Coll.10 – 42" Aluminum Stair Treads / Marche en aluminium

14137

14142

14147

1

Coll.10 – 48" Aluminum Stair Treads / Marche en aluminium

14138

14143

14148

1

Coll.10 – 60" Aluminum Stair Treads / Marche en aluminium

14139

14144

14149

1

Collection **10**

1 - 7

Steps / Marches



Easy assembly
Assemblage facile

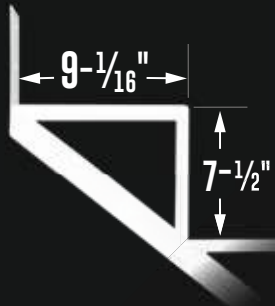

STEPS MARCHES	BEAM POUTRE
1 - 2 - 3	1-1/2" x 1-1/2"
4	1-1/2" x 2-1/4"
5 - 6 - 7	1-1/2" x 2-1/2"

# STEPS MARCHES	HEIGHT STRUCTURE HAUTEUR
1	15"
2	22-1/2"
3	30"
4	37-1/2"
5	45"
6	52-1/2"
7	60"

NAME / NOM

**WHITE
BLANC**

**BLACK
NOIR**

QTY / QTÉ
masterpack / carton

Coll.10 - 1-Step Aluminum Stair Stringer / Limon d'aluminium 1 marche	14021	14051	2
Coll.10 - 2-Steps Aluminum Stair Stringer / Limon d'aluminium 2 marches	14022	14052	2
Coll.10 - 3-Steps Aluminum Stair Stringer / Limon d'aluminium 3 marches	14023	14053	2
Coll.10 - 4-Steps Aluminum Stair Stringer / Limon d'aluminium 4 marches	14024	14054	2
Coll.10 - 5-Steps Aluminum Stair Stringer / Limon d'aluminium 5 marches	14025	14055	2
Coll.10 - 6-Steps Aluminum Stair Stringer / Limon d'aluminium 6 marches	14026	14056	2
Coll.10 - 7-Steps Aluminum Stair Stringer / Limon d'aluminium 7 marches	14027	14057	2



STAIR STRINGERS LIMONS 9-1/16"



**ALUMINUM
ALUMINIUM**

STAIR STRINGERS
& STAIR TREADS /
LIMONS ET MARCHES

8 - 15

Steps / Marches

Collection **10**



# STEPS MARCHES	HEIGHT STRUCTURE HAUTEUR
8	67-1/2"
9	75"
10	82-1/2"
11	90"
12	97-1/2"
13	105"
14	112-1/2"
15	120"

Easy assembly
Assemblage facile

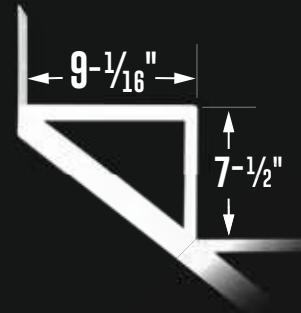

# STEPS # MARCHES	SECTION	SUPPORT + REINFORCEMENT RENFORT
8 - 9	2	NOT REQUIRED / NON REQUIS
10	2	INCLUDED / INCLUS
11 - 12 - 13 - 14 - 15	3	INCLUDED / INCLUS

NAME / NOM	WHITE BLANC	BLACK NOIR	QTY / QTÉ masterpack / carton
Coll.10 - 8-Steps Aluminum Stair Stringer / Limon d'aluminium 8 marches	14028	14058	1
Coll.10 - 9-Steps Aluminum Stair Stringer / Limon d'aluminium 9 marches	14029	14059	1
Coll.10 - 10-Steps Aluminum Stair Stringer / Limon d'aluminium 10 marches	14030	14060	1
Coll.10 - 11-Steps Aluminum Stair Stringer / Limon d'aluminium 11 marches	14031	14061	1
Coll.10 - 12-Steps Aluminum Stair Stringer / Limon d'aluminium 12 marches	14032	14062	1
Coll.10 - 13-Steps Aluminum Stair Stringer / Limon d'aluminium 13 marches	14033	14063	1
Coll.10 - 14-Steps Aluminum Stair Stringer / Limon d'aluminium 14 marches	14034	14064	1
Coll.10 - 15-Steps Aluminum Stair Stringer / Limon d'aluminium 15 marches	14035	14065	1

Collection **11**

Widths / Largeurs

36"

42"

48"

60"



Stainless
steel bolts
included
Boulons en
acier inoxydable inclus

- **Maintenance-free**
- **Available in 4 widths and 3 colors**
- **Sans entretien**
- **Disponible en 4 largeurs et 3 couleurs**

Nonslip
Antidérapant



NAME / NOM

**WHITE
BLANC**

**BLACK
NOIR**

**ANODIZED
ANODISÉ**

QTY / QTÉ
masterpack / carton

Coll.11 – **36"** Aluminum Stair Treads / Marche d'aluminium

16136

16141

16146

1

Coll.11 – **42"** Aluminum Stair Treads / Marche d'aluminium

16137

16142

16147

1

Coll.11 – **48"** Aluminum Stair Treads / Marche d'aluminium

16138

16143

16148

1

Coll.11 – **60"** Aluminum Stair Treads / Marche d'aluminium

16139

16144

16149

1



STAIR STRINGERS LIMONS 10-1/4"



**ALUMINUM
ALUMINIUM**

STAIR STRINGERS
& STAIR TREADS /
LIMONS ET MARCHES

1 - 7

Steps / Marches

Collection **11**



# STEPS MARCHES	HEIGHT STRUCTURE HAUTEUR
1	15"
2	22-1/2"
3	30"
4	37-1/2"
5	45"
6	52-1/2"
7	60"

STEPS MARCHES	BEAM POUTRE
1 - 2 - 3	1-1/2" x 1-1/2"
4	1-1/2" x 2-1/4"
5 - 6 - 7	1-1/2" x 2-1/2"

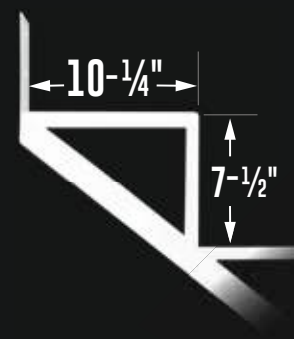

NAME / NOM

**WHITE
BLANC**

**BLACK
NOIR**

QTY / QTÉ
masterpack / carton

Coll.11 - 1- Step Aluminum Stair Stringer / Limon d'aluminium 1 marche	16001	16031	2
Coll.11 - 2- Steps Aluminum Stair Stringer / Limon d'aluminium 2 marches	16002	16032	2
Coll.11 - 3- Steps Aluminum Stair Stringer / Limon d'aluminium 3 marches	16003	16033	2
Coll.11 - 4- Steps Aluminum Stair Stringer / Limon d'aluminium 4 marches	16004	16034	2
Coll.11 - 5- Steps Aluminum Stair Stringer / Limon d'aluminium 5 marches	16005	16035	2
Coll.11 - 6- Steps Aluminum Stair Stringer / Limon d'aluminium 6 marches	16006	16036	2
Coll.11 - 7- Steps Aluminum Stair Stringer / Limon d'aluminium 7 marches	16007	16037	2

Collection **11**

8 - 14

Steps / Marches

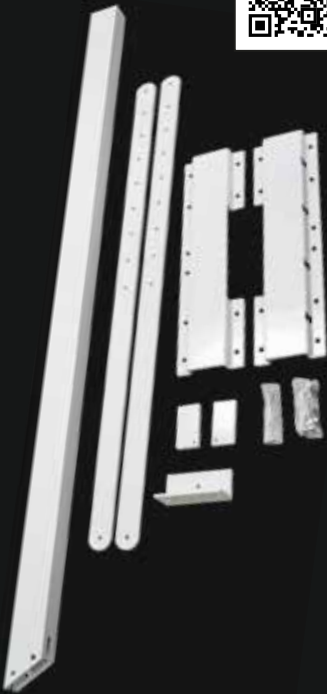

**Easy assembly
Assemblage facile**

MATERIAL REQUIRED / MATÉRIAUX REQUIS

# OF STEPS # MARCHES	BLACK STRINGERS LIMONS NOIRS	WHITE STRINGERS LIMONS BLANCS
8	16034 + 16034	16004 + 16004
9	16035 + 16034	16005 + 16004
10	16035 + 16035	16005 + 16005
11	16036 + 16035	16006 + 16005
12	16036 + 16036	16006 + 16006
13	16037 + 16036	16007 + 16006
14	16037 + 16037	16007 + 16007

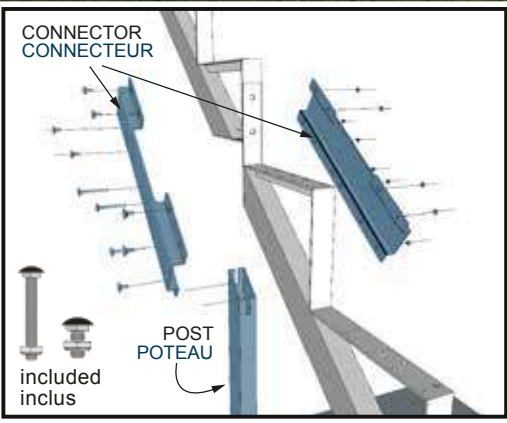

NAME / NOM

WHITE / BLANC

BLACK / NOIR

QTY / QTÉ
masterpack / carton

Coll.11 – Aluminum Stair Stringer Connector & Post /
Connecteur + poteau pour limon en aluminium

16020

16050

1

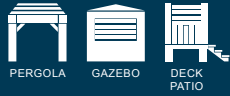

PERGOLA HARDWARE QUINCAILLERIE POUR PERGOLA



**GALVANIZED
STEEL
ACIER
GALVANISÉ**

GAZEBO / PERGOLA /
OUTDOOR FURNITURE /
MOBILIER EXTÉRIEUR

Pergola Hardware – Post Bases Quincaillerie pour Pergola – bases

#1 Kit
Ensemble



THIS BOX CONTAINS:
LA BOÎTE CONTIENT:
4 BASES
2 SUPPORTS / BASE

- For 4" x 4" or 6" x 6" posts
- For patio, terrace or gallery
- Pour poteau 4" x 4" ou 6" x 6"
- Pour patio, terrasse ou galerie

Audrey & Charlie

Pergola Hardware – Bracket Set Quincaillerie pour Pergola – ensemble d'équerres

#2 Kit
Ensemble



Ideal to build a pergola, gazebo or any other structure requiring square brackets

Idéal pour construire une pergola, un gazebo ou toute autre structure nécessitant des équerres

Maxime Le Bon

NAME / NOM

**MATTE BLACK
NOIR MAT**

QTY / QTÉ
masterpack / carton

#1 Pergola Hardware – Post Bases / Quincaillerie pour Pergola – bases

12071

1

#2 Pergola Hardware – Bracket Set / Quincaillerie pour Pergola – ensemble d'équerres

12072

1

Kit
Ensemble

#3

Pergola Hardware – Shutters
Quincaillerie pour Pergola – volets articulés



For a pergola from
9' x 9' up to 9' x 12'

Pour pergola de
9' x 9' jusqu'à 9' x 12'



- **4 sections** of hinged shutters with metal rod and hook for opening and/or closing of the shutters
- Each hinged shutter set closes individually to provide desired shade
- **4 sections** de volets articulés pour plafond et une tige de métal avec crochet pour ouverture et/ou la fermeture du volet
- Les sections de volets articulés se ferment individuellement pour fournir l'ombre souhaitée



These kits may be
purchased individually

Ces ensembles peuvent être
achetés individuellement



**COMPLETE
PERGOLA
COMPLÈTE**

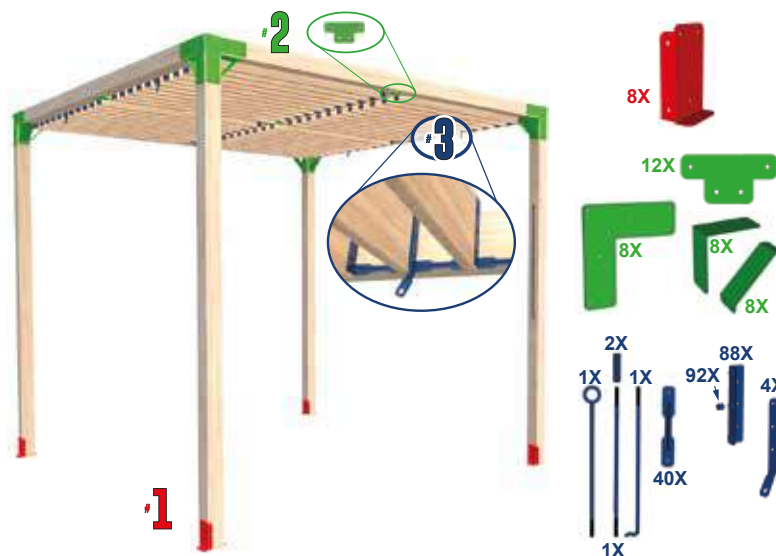

For complete pergola combine with #2 and #3 kits.
However, these kits may be purchased individually.

Pour une pergola complète, combinez avec les ensembles #2 et #3.
Cependant, ces ensembles peuvent être achetés individuellement.

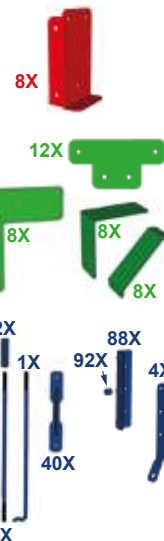

**COMPLETE
PERGOLA
COMPLÈTE**

NAME / NOM

#

BLACK / NOIR

QTY / QTE
masterpack / carton

#3 Pergola Hardware – Shutters / Quincaillerie pour Pergola – volets articulés

12073

1

Display / Présentoir

12074

1

GAZEBO ROOF BRACKETS

Quincaillerie pour
TOITURE DE GAZÉBO



**STEEL
ACIER**

GAZEBO / PERGOLA /
OUTDOOR FURNITURE /
MOBILIER EXTERIEUR



All of the hardware necessary to assemble a gazebo roof with a 4/12 pitch
Quincaillerie nécessaire pour assembler le toit d'un gazébo avec une pente de 4/12

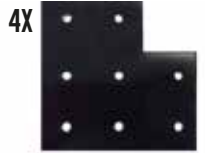

- An easy way to build a gazebo roof
- Possible dimensions 10' x 10' up to 10' x 20'
- Permet de construire le toit d'un gazébo facilement
- Dimensions possibles 10' x 10' jusqu'à 10' x 20'

© Louise Lavigneur

NAME / NOM

Gazebo Roof Bracket / Quincaillerie pour toiture de Gazébo

BLACK / NOIR

12075

QTY / QTÉ
masterpack / carton

1

**STEEL
ACIER**



**BENCH BRACKET
SUPPORT DE BANC**

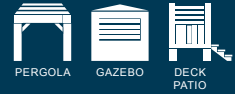

- Back support included
- Only uses 5" of the deck space
- Storage space under the bench
- One-piece bracket
- For uses on decks, balconys, docks...
- Support de dossier inclus
- Utilise seulement 5" d'espace du patio
- Espace de rangement en dessous du banc
- Support en une pièce
- Pour utilisation sur patio, balcon, quai...



**Simple and easy
installation**

**Simple et facile
d'installation**



NAME / NOM

Bench Bracket / Support de banc

BLACK / NOIR

14300

KHAKI / KAKI

14301

CEDAR / CÈDRE

14302

QTY / QTÉ
masterpack / carton

4



SWING BRACKET KIT

Quincaillerie pour
BALANÇOIRE



**STEEL
ACIER**

GAZEBO / PERGOLA /
OUTDOOR FURNITURE /
MOBILIER EXTERIEUR



- Many possibilities
- Eliminates calculation of cutting angles
- For a bench up to 6'
- Multitude de possibilités
- Élimine le calcul des angles de coupe
- Pour un banc allant jusqu'à 6'

Supports up to 500 lbs
Supporte jusqu'à 500 lb



NAME / NOM

Swing Bracket Kit / Quincaillerie pour balançoire

BLACK / NOIR

12085

QTY / QTE
masterpack / carton

5



- Building kit for gliding bench 42" to 48"
 - Template provided for easy cuts
 - Smooth gliding
 - Ensemble pour fabriquer un banc coulissant de 42" à 48"
 - Patron fourni pour faciliter les coupes
 - Roulement doux
- Supports up to 500 lbs
Supporte jusqu'à 500 lb



NAME / NOM

Glider Bench Kit / Quincaillerie pour banc coulissant

MATTE BLACK / NOIR MAT

12082

QTY / QTE
masterpack / carton

1

CLOTHESLINE POST POTEAU DE CORDE À LINGE



**STEEL
ACIER**

ACCESSORIES
ACCESSOIRES

5' in the ground and 11' above ground
5' dans le sol et 11' hors-sol

16'



CAN BE USED FOR / PEUT ÊTRE UTILISÉ POUR :

PARABOLIC ANTENNA
ANTENNES
PARABOLIQUES



SECURITY CAMERA
CAMÉRAS DE
SURVEILLANCE



SECURITY LIGHTS
LUMIÈRES
DE SÉCURITÉ



- Safe
- No ladder or concrete required
- Sécuritaire
- Échelle ou béton non requis

48" Extension / Rallonge 48"

4'

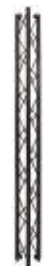
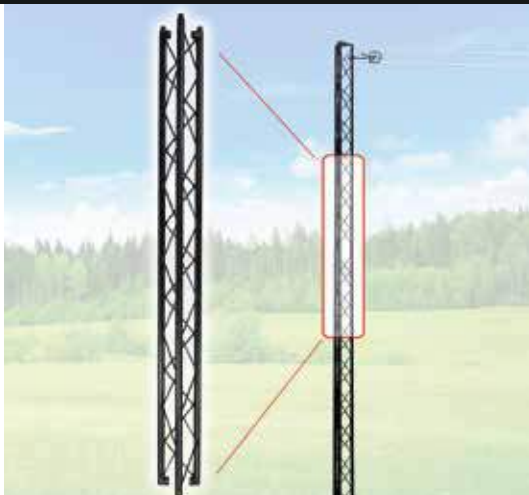

To extend the clothesline post up to 15' max above the ground

Pour rallonger le poteau de corde à linge jusqu'à 15' maximum hors-sol

NAME / NOM

Clothesline Post / Poteau de corde à linge

Clothesline Post – 48" Extension / Poteau de corde à linge – Rallonge 48"

BLACK / NOIR

10736

10738

QTY / QTÉ
masterpack / carton

1

1

15"



- Exclusive and sturdy clamp system
- Allows various storage structures using 2" x 4"
- Sturdy
- Système de serrage exclusif
- Permet diverses structures de rangement en utilisant des 2" x 4"
- Robuste



- For 16" logs
- Kindling wood
- Tires
- Garden tools...
- Pour bûches de 16"
- Bois d'allumage
- Pneus
- Accessoires de jardin...



NAME / NOM

15" 2" x 4" Rack Structure / Structure de rangement 2" x 4"

BLACK / NOIR

12060

QTY / QTÉ
masterpack / carton

10

2" x 4" RACK STRUCTURE STRUCTURE DE RANGEMENT 2" x 4"



**STEEL
ACIER**

ACCESSORIES
ACCESSOIRES



24"



Multiple 2" x 4" storage racks can be used to build shelves, workbench...

- For shelves 22" to 24" wide
- In the garage, basement or workshop

Plusieurs structures de rangement 2" x 4" peuvent être utilisées pour construire diverses étagères, établi...

- Pour tablettes de 22" à 24" de large
- Dans le garage, au sous-sol ou dans l'atelier



NAME / NOM

24" 2" x 4" Rack Structure / Structure de rangement 2" x 4"

BLACK / NOIR

12061

QTY / QTE
masterpack / carton

4

**YELLOW
ZINC
ZINC JAUNE**



**REMOVABLE FLOOR ANCHOR
ANCRAGE À PLANCHER AMOVIBLE**



This part is welded,
the ring cannot open
Partie soudée,
l'anneau ne peut pas
s'ouvrir

- Sturdy
- Reusable
- Rust resistant
- 150 lbs of resistance

- Solide
- Réutilisable
- Résistant à la rouille
- 150 lb de résistance

4 Anchors
per pack
Anchres
par paquet



Very simple!
Install between deck
boards up to 1-3/4" thick

Très simple!
Installer entre les planches
du patio jusqu'à une
épaisseur de 1-3/4"

NAME / NOM

Removable Floor anchor / Ancre à plancher amovible

**YELLOW ZINC
ZINC JAUNE**

12120

QTY / QTÉ
masterpack / carton

10

**YELLOW ZINC
ZINC JAUNE**

**ANCHOR CABLE
ANCRAGE À CÂBLE**



Installation

- Push in the anchor using a metal rod (or 1/2" rebar) until the ring is level with the ground
- Remove the rod
- Pull sharply on the ring to tilt the anchor

Installation

- Enfoncer l'ancrage à l'aide d'une tige en métal (ou une tige d'armature 1/2") jusqu'à ce que l'anneau soit égal au sol
- Retirer la tige
- Tirer brusquement sur l'anneau pour faire basculer l'ancrage

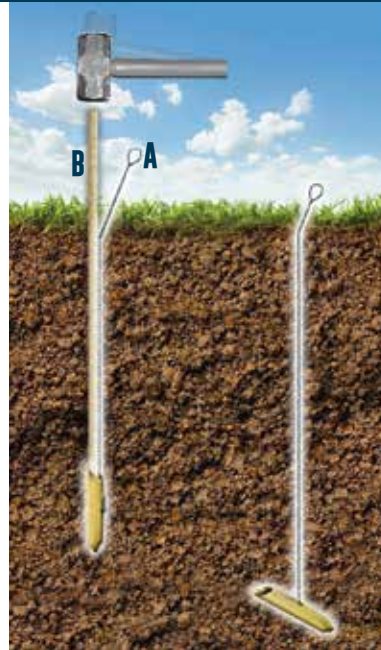

**Ideal for car shelter,
gazebo, awning...**

**Idéal pour retenir abris
d'auto, gazebo, auvent...**

Can hold up to 800 lbs
Peut retenir jusqu'à 800 lb

NAME / NOM

A - Cable Anchor / Ancre à câble

B - Installation Rod for Cable Anchor / Tige d'installation pour ancre à câble

C - 4 Cable Anchors & Installation Rod - kit
Kit de 4 ancrages à câble & tige d'installation

**YELLOW ZINC
ZINC JAUNE**

13050

13051

13052 / 53

QTY / QTÉ
masterpack / carton

25

12

45 / 5



ROOF BRACKET ÉTRIER À TOITURE



STEEL ACIER

ACCESSORIES
ACCESSOIRES

**3 BOLTS WITH
LOCKNUTS**
**3 BOULONS AVEC
ÉCROUS AUTOBLOQUANTS**

**REINFORCEMENT
ANGLE**
**ANGLE DE
RENFORCEMENT**

**EXCLUSIVE LOCK
BARRURE EXCLUSIVE**

**REINFORCED STEEL
ACIER RENFORCIT**

A

50 degree
50 degrés



B

3 positions



**FOR A 7/12 TO 24/12
ROOF PITCH**

- Steel bracket
- Durable
- Easy to install and remove without damaging shingles

**POUR PENTE DE TOIT
DE 7/12 À 24/12**

- Étrier en acier
- Durable
- Facile à installer et retirer sans endommager le bardeau

NAME / NOM

ORANGE

QTY / QTÉ
masterpack / carton

A - Roof Bracket – 50 degree / Étrier à toiture – 50 degrés

14011

8

B - Roof Bracket – 3 positions / Étrier à toiture – 3 positions

14012

2

**STEEL
ACIER**



**10' X 10' RETRACTABLE SHELTER
ABRI RÉTRACTABLE 10' X 10'**



- 10' x 10'
- Can be installed in under 5 minutes
- 4 possible heights
- Ideal for all outdoor activities
- Very sturdy
- **WATER RESISTANT**
- 10' x 10'
- S'installe en moins de 5 minutes
- Réglable à 4 hauteurs
- Idéal pour toute activité extérieure
- Construction solide
- **RÉSISTANT À L'EAU**



**UNFOLD
DÉPLIEZ**



**STRETCH
ÉTIREZ**

**CARRY BAG
INCLUDED /
SAC DE TRANSPORT INCLUS**



NAME / NOM

Retractable Shelter 10' X 10' / Abri rétractable 10' X 10'

ZINC PLATED / PLAQUÉ ZINC

13510

QTY / QTÉ
masterpack / carton

4

PYLEX POWER ELEVATOR

Platform / Plateforme



**ALUMINUM
ALUMINIUM**

**PLATFORM
PLATEFORME**



Bear Rock Electric Inc



Bear Rock Electric Inc



- Aluminum platform used to support a generator
- Maintenance free
- Plateforme en aluminium servant à soutenir une génératrice
- Nécessite aucun entretien

NAME / NOM

Pylex Power Elevator - Platform / Plateforme

BLACK / NOIR

10707

QTY / QTÉ
masterpack / carton

1

**STEEL
ACIER**



PYLEX POWER ELEVATOR

Platform + Helical piles
Plateforme + Vis de fondation de **32"**



Stuller Power Solutions

THE OPTIMAL SOLUTION FOR FLOOD PRONE AREAS

- 32" helical piles – Used to support the generator platform
- Ideal for uneven terrain or elevation over 24"

LA SOLUTION OPTIMALE POUR LES ZONES INONDABLES

- Vis de fondation de 32" – Servant à soutenir une plateforme pour génératrice
- Idéal pour les terrains accidentés ou les élévations de plus de 24"



Stuller Power Solutions

NAME / NOM

Pylex Power Elevator - 32"

BLACK / NOIR

10706

QTY / QTÉ
masterpack / carton

1

Pylex Power Elevator - Platform / Plateforme

10707

1

PYLEX POWER ELEVATOR

Platform + Helical piles
Plateforme + Vis de fondation de 50"



**STEEL
ACIER**

**PLATFORM
PLATEFORME**



Stuller Power Solutions



Stuller Power Solutions

**IDEAL FOR UNEVEN
TERRAIN OR ELEVATION
UP TO 24"**

- 50" helical piles – Used to support the generator platform
- The optimal solution for flood prone areas

**IDÉAL POUR LES TERRAINS
ACCIDENTÉS OU LES
ÉLÉVATIONS JUSQU'À 24"**

- Vis de fondation de 50" – Servant à soutenir une plateforme pour génératrice
- La solution optimale pour les zones inondables

NAME / NOM

Pylex Power Elevator - 50"

Pylex Power Elevator - Platform / Plateforme

BLACK / NOIR

10705

10707

QTY / QTÉ
masterpack / carton

1

1



2023 CATALOGUE
PDF VERSION
SCAN HERE / ICI

400, rue du Parc-Industriel, Shawinigan, QC, Canada G9N 6T5
1-800-264-1881 / www.pylex.com

Order / Commande : orderdesk@pylex.com

Technical support / Soutien technique : info@pylex.com / 1-800-264-1881

Chat / Clavardage : www.pylex.com

