



ITEM # 16050

Connecteur + poteau pour limon en aluminium / Aluminum stringer connector + post

collection

11

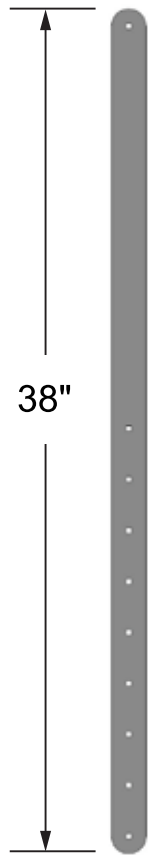
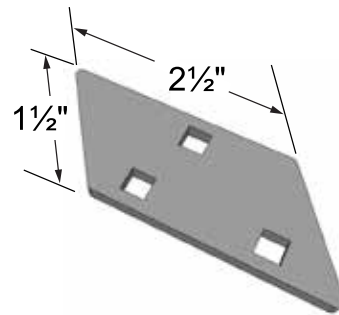
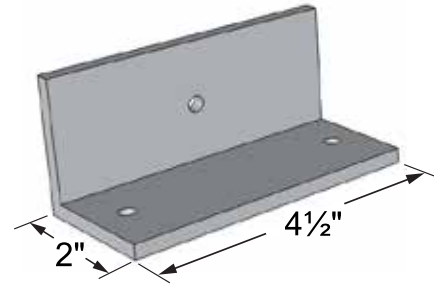
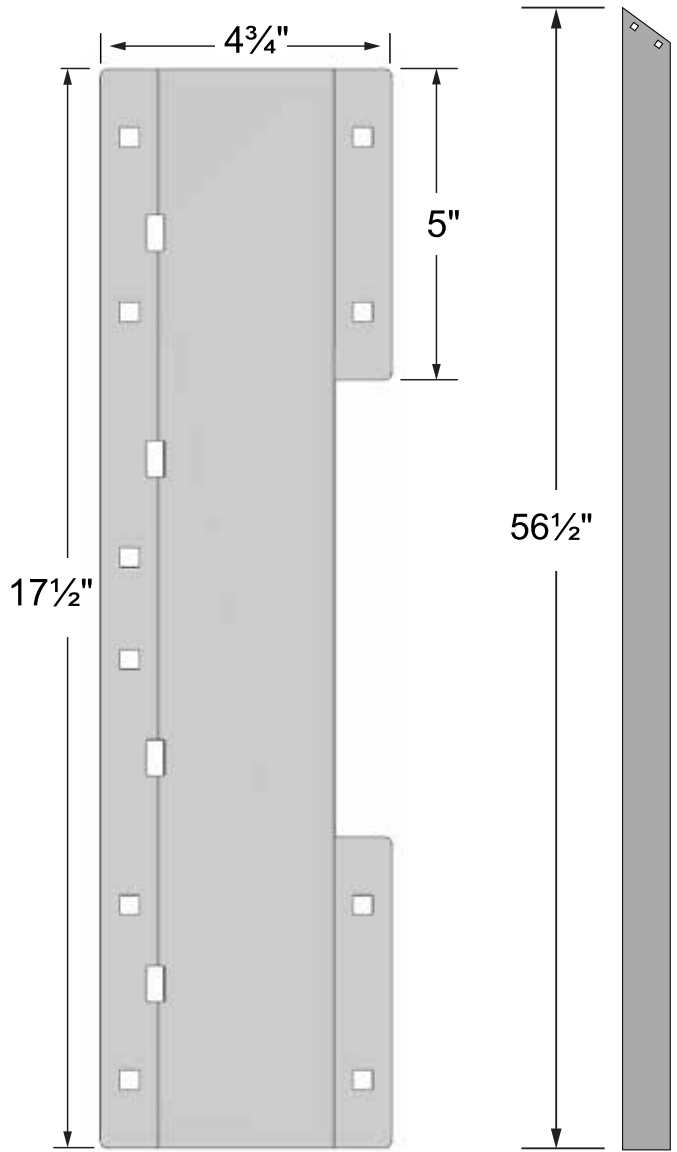

**EASY TO INSTALL
INSTALLATION FACILE**

NOIR / BLACK

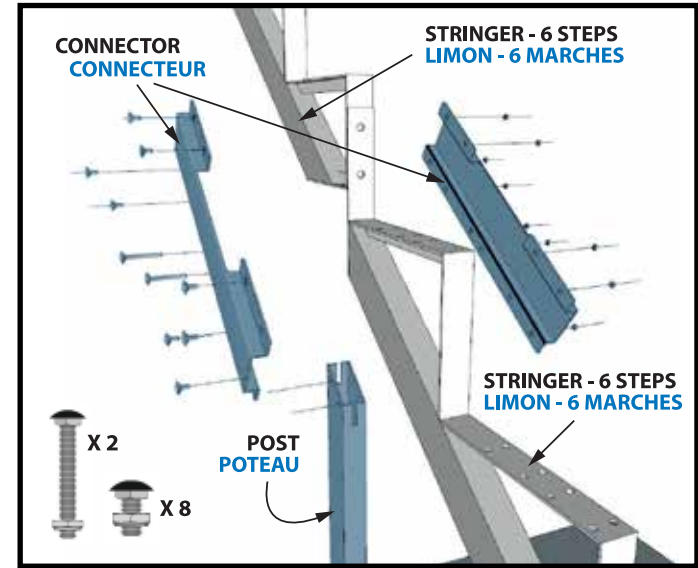

ALL BOLTS AND SCREWS ARE INCLUDED

TOUS LES BOULONS ET VIS SONT INCLUS

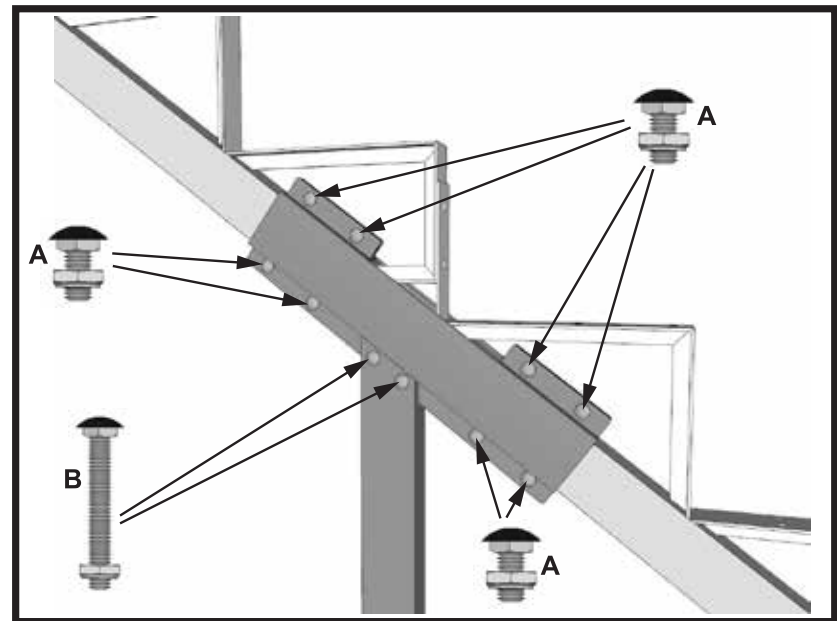



Compatible avec les limons Pylex / Compatible with Pylex stringers:
16034 - 16035 - 16036 - 16037

MATERIAL REQUIRED / MATÉRIAUX REQUIS

# MARCHES # OF STEPS	LIMONS + CONNECTEUR NOIRS BLACK STRINGERS + CONNECTOR	*HAUTEUR DU POTEAU *HEIGHT OF POST
9	16035 + 16020 + 16034	35"
10	16035 + 16020 + 16035	
11	16036 + 16020 + 16035	42"
12	16036 + 16020 + 16036	
13	16037 + 16020 + 16036	50"
14	16037 + 16020 + 16037	
15	16038 + 16020 + 16037	
16	16038 + 16020 + 16038	**56"

* LA HAUTEUR DU POTEAU EST APPROXIMATIVE ;
ELLE DÉPEND DE LA DÉNIVELLATION DU TERRAIN.

** IL FAUT AJOUTER UNE DALLE DE BÉTON DE 1".

* POST HEIGHT IS APPROXIMATE ;
IT DEPENDS ON THE SLOPE OF THE GROUND.

** A 1-INCH CONCRETE SLAB MUST BE ADDED.

Nombre de limons Pylex recommandés :
Number of Pylex stair risers recommended:

24" à/to 48" = 2

60" = 2*

* 4 limons requis pour un escalier de 13/14 marches
4 stringers required for a staircase with 13/14 steps

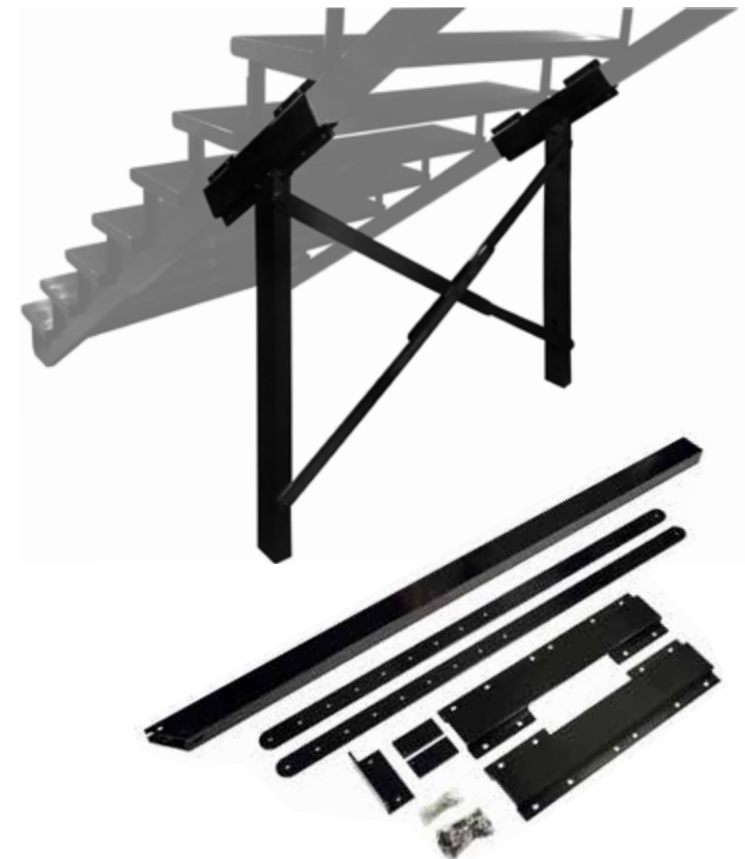



ITEM # 16050

Connecteur + poteau pour limon en aluminium / Aluminum stringer connector + post

NOIR / BLACK

9 STEPS MARCHES

= 1X 16034 + 1X 16050
+ 1X 16035

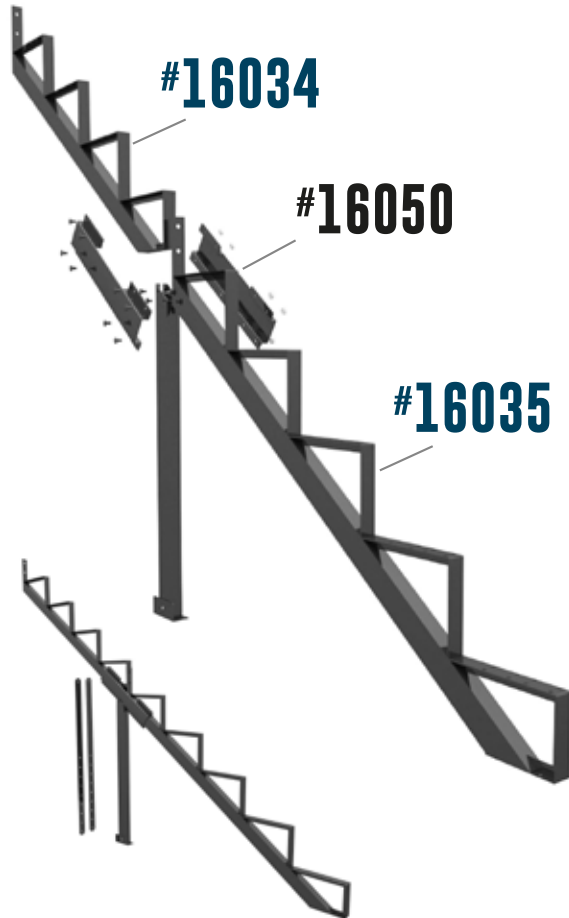

10 STEPS MARCHES

= 2X 16035 + 1X 16050



11 STEPS MARCHES

= 1X 16035 + 1X 16050
+ 1X 16036

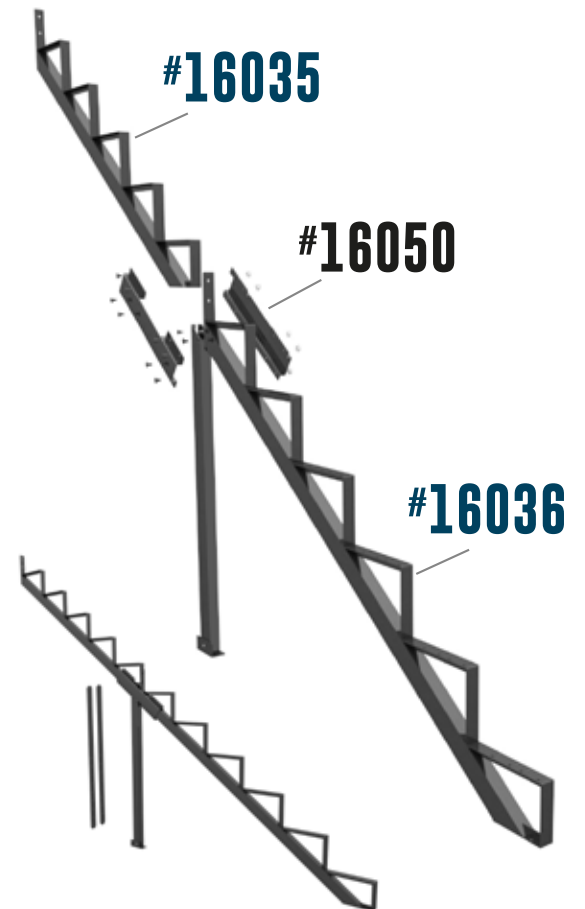

12 STEPS MARCHES

= 2X 16036 + 1X 16050

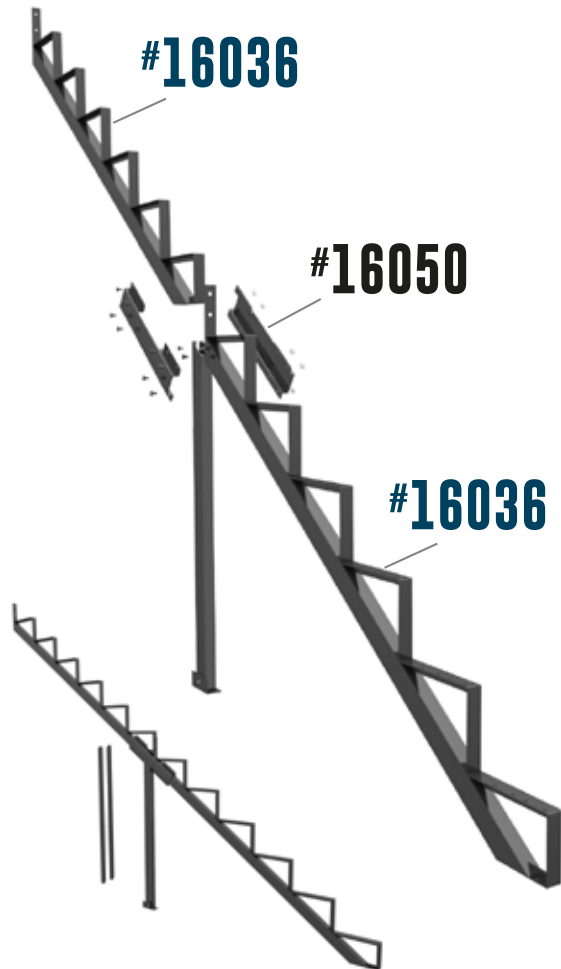

13 STEPS MARCHES

= 1X 16036 + 1X 16050
+ 1X 16037

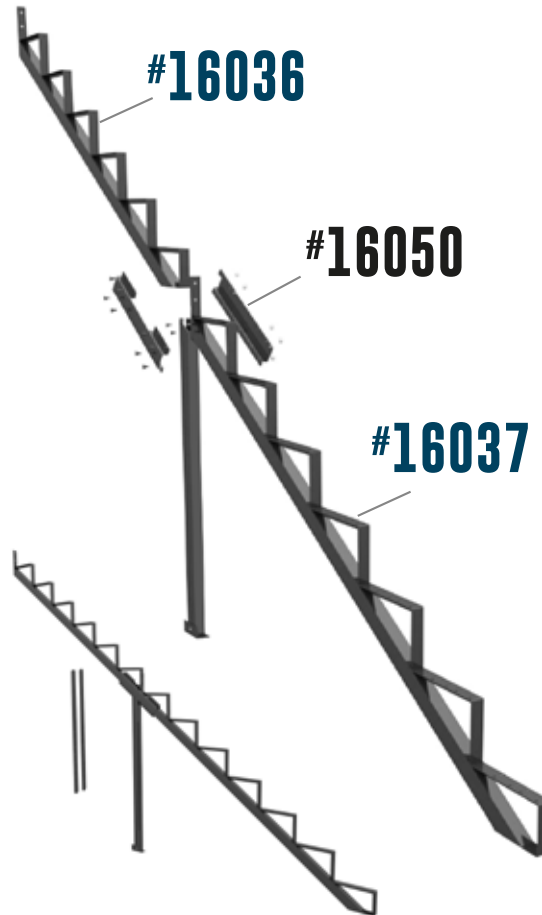

14 STEPS MARCHES

= 2X 16037 + 1X 16050

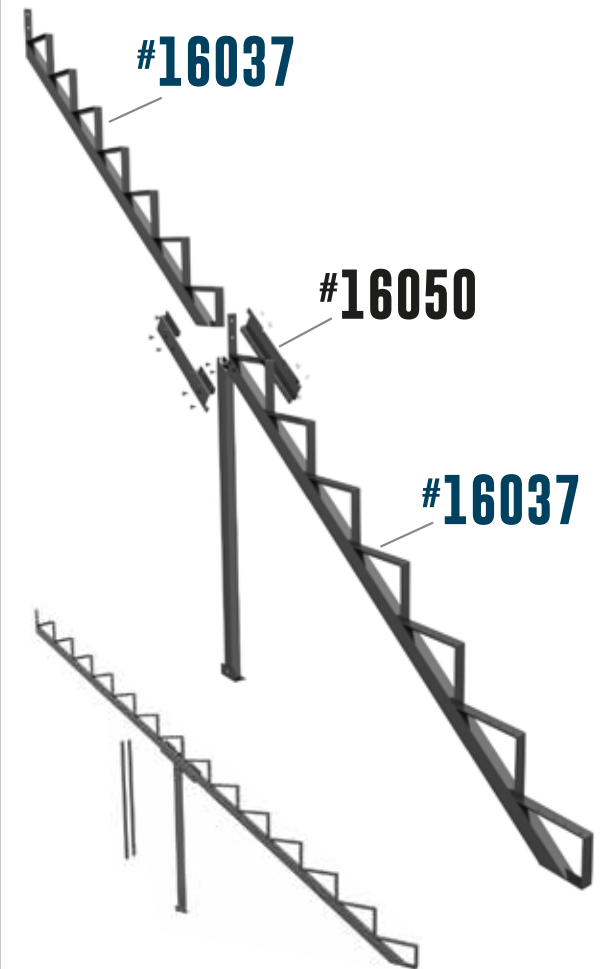



ITEM # 16050

Connecteur + poteau pour limon en aluminium / Aluminum stringer connector + post

NOIR / BLACK

15 STEPS MARCHES

= 1X 16038 + 1X 16050
+ 1X 16037

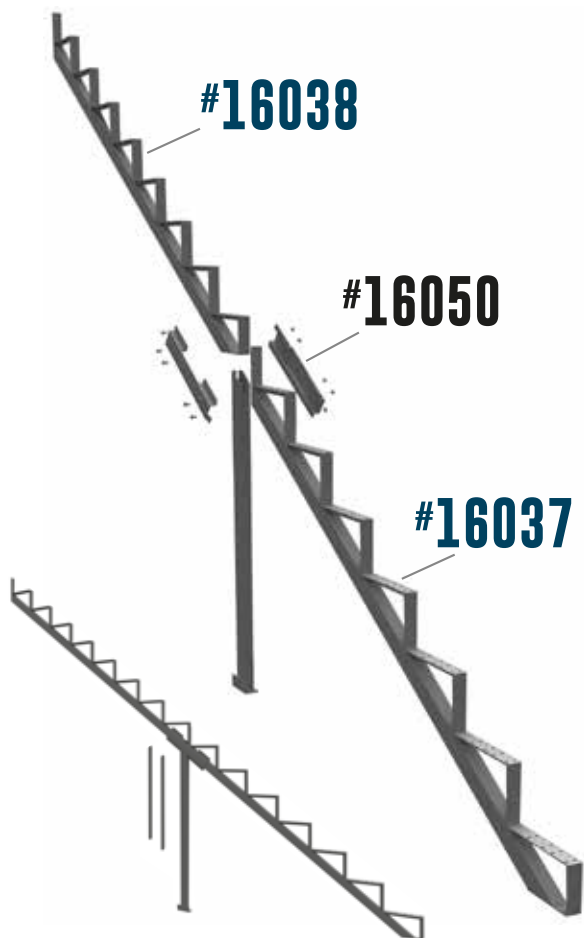

16 STEPS MARCHES

= 2X 16038 + 1X 16050

