



ITEM # 14147 - Marche en aluminium / aluminium Stair tread - ANODISÉ / ANODIZED 42"

POIDS / WEIGHT : 2,70 Kg / 5,90 Lbs



NONSLIP / ANTIDÉRAPANT

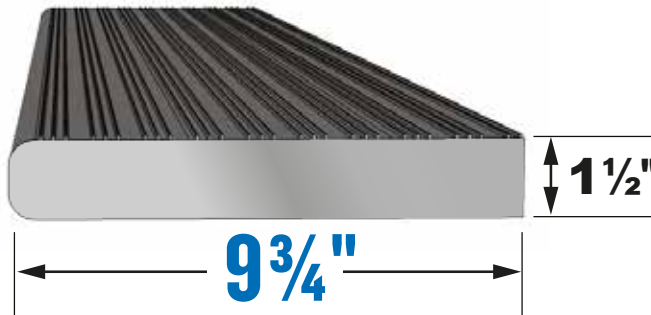

FOR COMMERCIAL USE
PLEASE CONTACT US
POUR USAGE
COMMERCIAL VEUILLEZ
COMMUNIQUER
AVEC NOUS.



Pour le nombre de limons Pylex recommandés veuillez vous référer au limons.
For the recommended number of Pylex stair risers please refer to the stair risers.

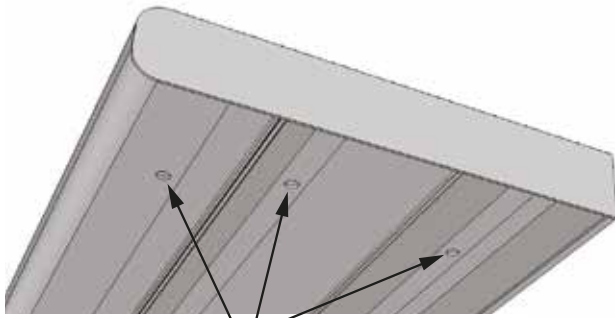

SANS ENTRETIEN ET PRÉALABLEMENT PERCÉE. BOULONS D'INSTALLATION INCLUS
MAINTENANCE FREE WITH PRE-DRILLED HOLES. INSTALLATION BOLTS & NUTS INCLUDED

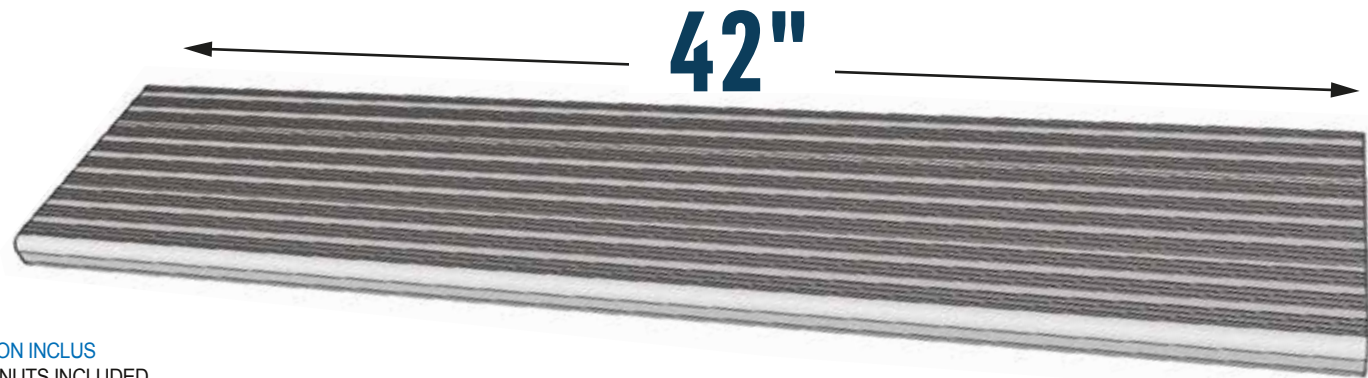

INSTALLATION OF A STRINGER INSTALLATION D'UN LIMON

DE
CHAQUE
CÔTÉS
OF
EACH
SIDES

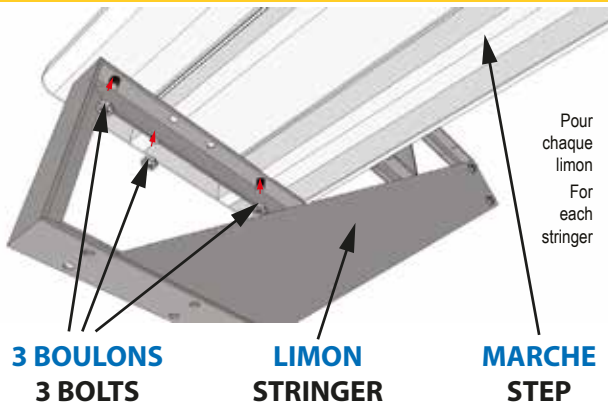

INSTALLATION OF A HANDRAIL INSTALLATION D'UNE RAMPE

RAMPE VENDUE SÉPARÉMENT
HANDRAIL SOLD SEPARATELY

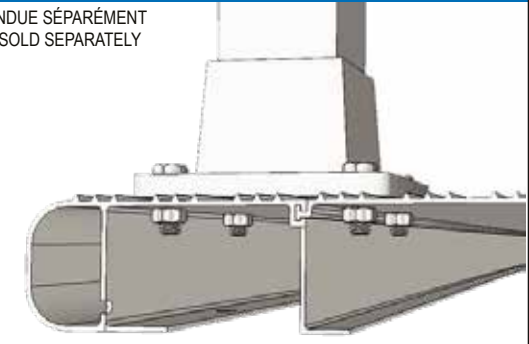
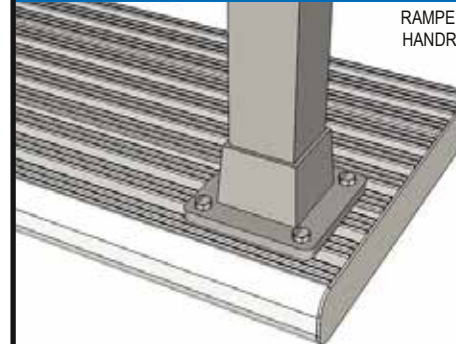

IMPORTANT

Install the bolts of the post as closely as possible to the vertical walls
Installer les boulons du poteau le plus près possible des parois verticales

S'ADAPTE À TOUS LES TYPES DE LIMONS EN ALUMINIUM OU EN ACIER. / THEY FIT WITH ALUMINIUM STAIR RISERS OR ANY KIND OF ALUMINIUM OR STEEL STRINGERS AVAILABLE.

