

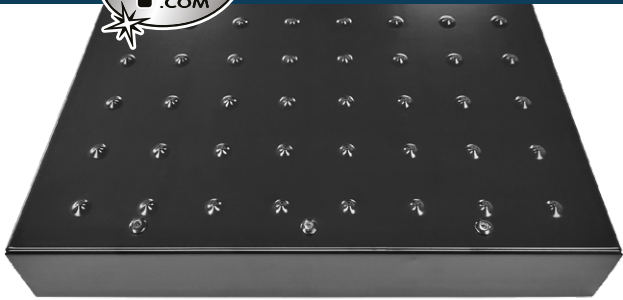

ITEM # 13941 - Marche en acier / Steel Stair tread - 36"

NOIR / BLACK

POIDS / WEIGHT : 4,00 Kg / 8,80 Lbs



ANTIDÉRAPANT / NONSLIP

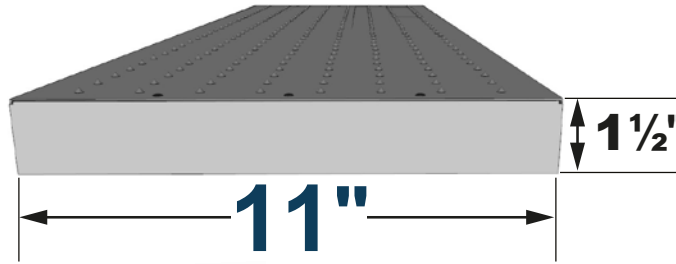

**POUR USAGE COMMERCIAL
VEUILLEZ COMMUNIQUER
AVEC NOUS.
FOR COMMERCIAL USE
PLEASE CONTACT US.**

- Boulons d'installation inclus
- COMPATIBLE avec les limons en acier Pylex # 13901 à 13918

Nombre de limons Pylex recommandés : **2**
Recommended number of Pylex stair stringers :

- Installation bolts included
- COMPATIBLE with steel stair stringers Pylex # 13901 to 13918

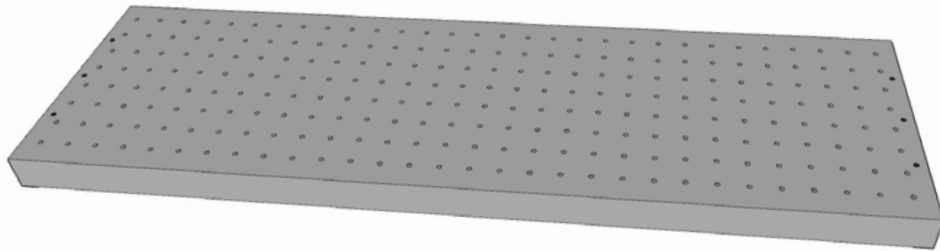

36"

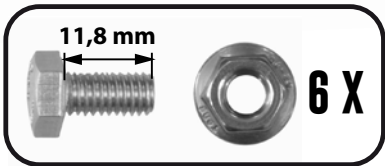

6 X Ø 3/8"

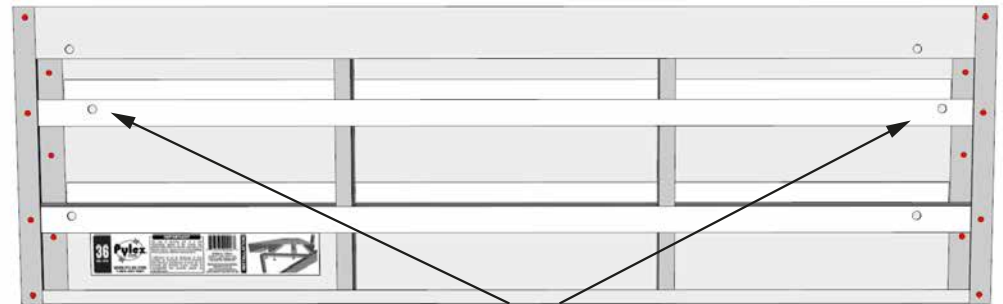

PRÉALABLEMENT PERCÉE.
PRE-DRILLED HOLES.

INSTALLATION ON A STRINGER INSTALLATION SUR UN LIMON

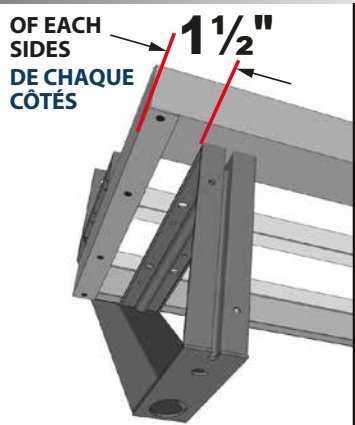

OF EACH SIDES
DE CHAQUE CÔTÉS

1 1/2"

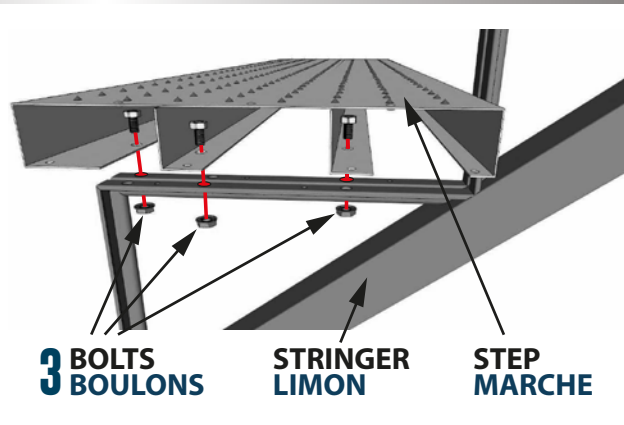

3 BOLTS BOULONS **STRINGER LIMON** **STEP MARCHÉ**

INSTALLATION D'UNE RAMPE INSTALLATION OF A HANDRAIL

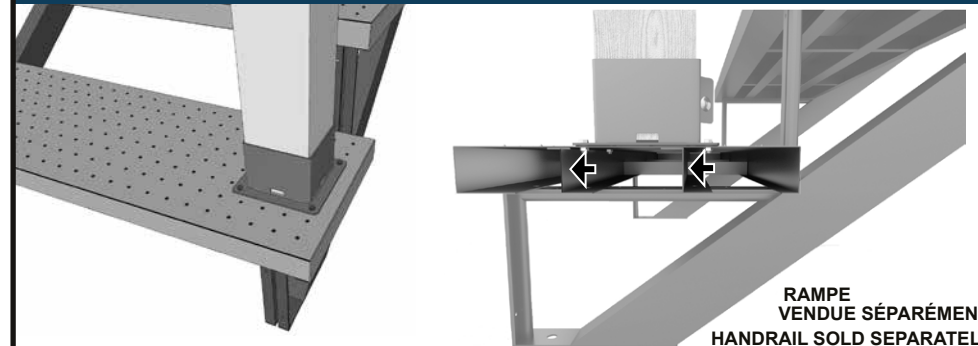

RAMPE
VENDUE SÉPARÉMENT
HANDRAIL SOLD SEPARATELY

IMPORTANT

Install the bolts of the post as closely as possible to the vertical walls
Installer les boulons du poteau le plus près possible des parois verticales

