

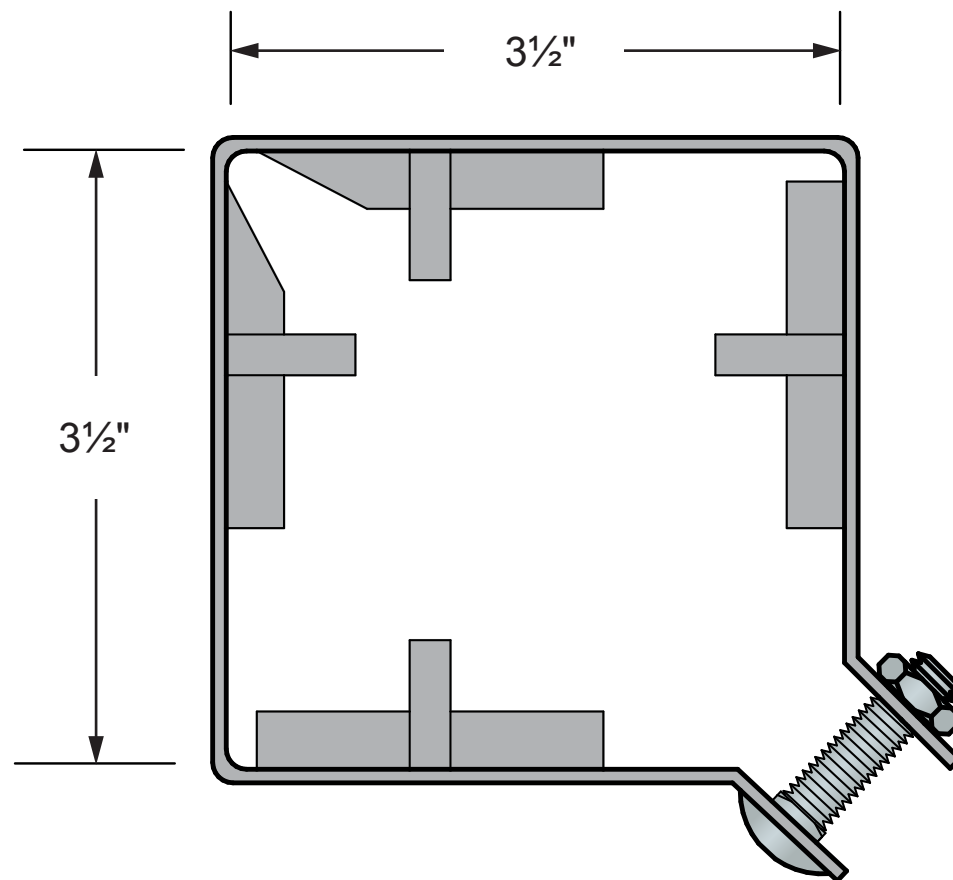

ITEM # 13063 - Ancrage à béton 44 / Concrete Anchor 44 - NOIR / BLACK

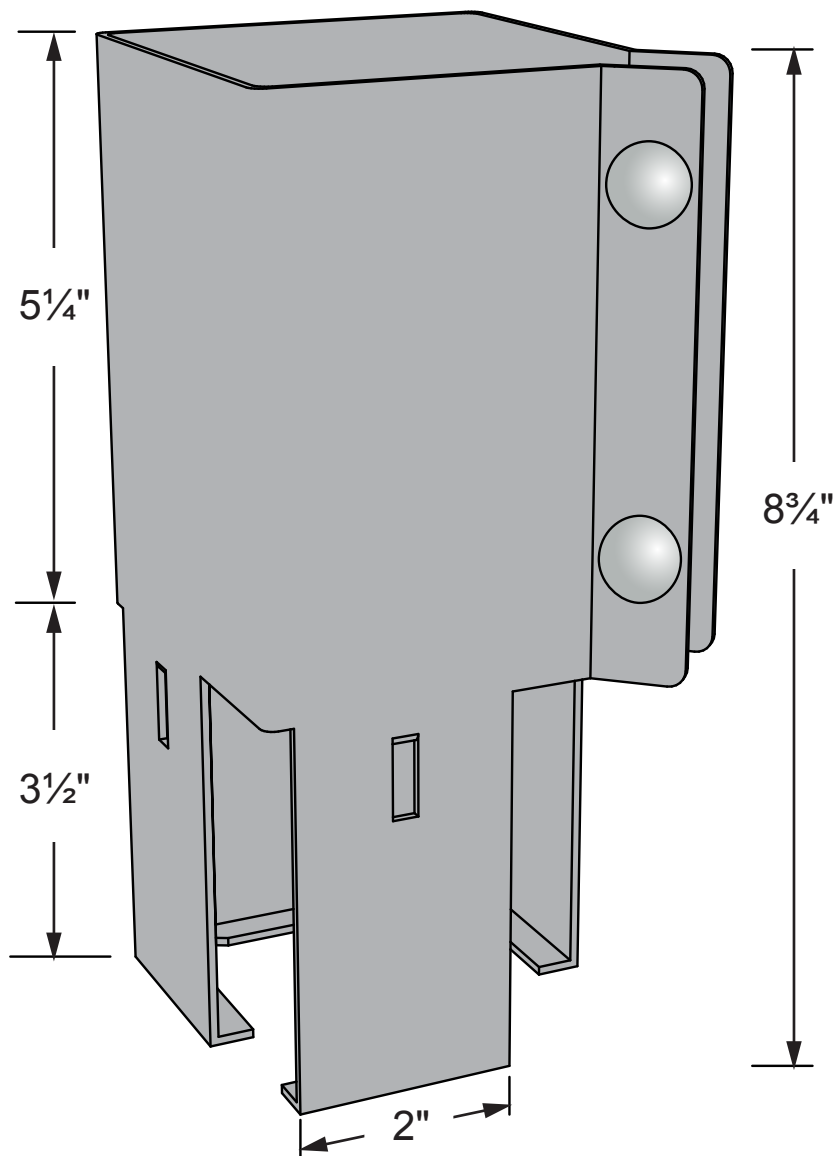

S'utilise avec un poteau de 4 po x 4 po
(mesure réelle de 3 1/2" x 3 1/2" en magasin).
Fits a nominal standard 4 in x 4 in posts
(actual 3 1/2" x 3 1/2" post on market).

POIDS / WEIGHT : 1,10 Kg