

Vous avez ici  
la version la  
plus récente  
du vidéo  
d'installation



Vous avez ici  
la version la  
plus récente  
du guide  
d'installation



## **GUIDE D'INSTALLATION**

# **SYSTÈME DE STORE POUR PATIO**

**# 11060**



### **Question? - Contactez-nous:**

Contactez d'abord notre sympathique équipe de service à la clientèle pour obtenir de l'aide.

Courriel : [info@pylex.com](mailto:info@pylex.com) ou par téléphone : 1-800-264-1881

Lundi au vendredi : 8h30 à 16h30 UTC

Le remplacement des pièces endommagées ou manquantes sera expédié rapidement.

Rev.: 32-0704



**ACCESSOIRES POUR PATIO ET CLÔTURE**  
**WWW.PYLEX.COM / 1 800-264-1881**

## LISTE DES PIÈCES

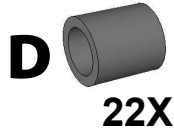
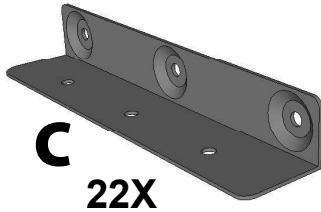
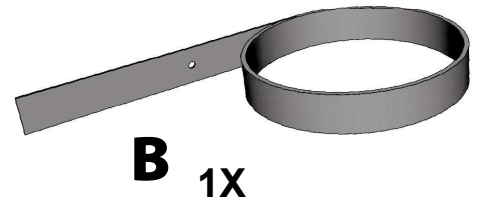
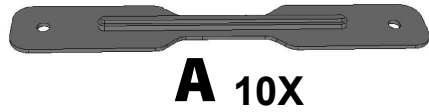

## OUTILS REQUIS



pour structure de  
2" x 6" / 6" x 6"



NOMBRE DE PLANCHES		OUVERTURE REQUISE	
<p>NÉCESSITE <b>1</b> BOITE</p>	2	10"	254 mm
	3	14- <sup>5</sup> / <sub>16</sub> "	364 mm
	4	18- <sup>11</sup> / <sub>16</sub> "	474 mm
	5	23"	584 mm
	6	27- <sup>5</sup> / <sub>16</sub> "	694 mm
	7	31- <sup>11</sup> / <sub>16</sub> "	804 mm
	8	36"	914 mm
	9	40- <sup>5</sup> / <sub>16</sub> "	1024 mm
	10	44- <sup>5</sup> / <sub>8</sub> "	1134 mm
	11	49"	1244 mm
	<p>NÉCESSITE <b>2</b> BOITES</p>	12	53- <sup>5</sup> / <sub>16</sub> "
13		57- <sup>5</sup> / <sub>8</sub> "	1464 mm
14		62"	1574 mm
15		66- <sup>5</sup> / <sub>16</sub> "	1684 mm
16		70- <sup>5</sup> / <sub>8</sub> "	1794 mm
17		75"	1904 mm
18		79- <sup>5</sup> / <sub>16</sub> "	2014 mm

# ÉTAPE 1 - MESURES



**B 1X**

**POTEAU 4"X4"  
MADRIER 2"X4"**

**OU**

**POTEAU 6"X6"  
MADRIER 2"X6"**

**1-3/4"**

**2-3/4"**

Allez à la page suivante

Allez à la page 12

**PLANCHES DE 5/8" X 6" À  
1-1/4" X 6" REQUIS.**

*(mesure réelle de 5-1/2" en magasin).*

**MESURER  
L'OUVERTURE**

**VOIR PAGE  
PRÉCÉDENTE  
POUR LE NOMBRE  
DE PLANCHES**

## ÉTAPE 2 - INSTALLATION DE LA BANDE TROUÉE

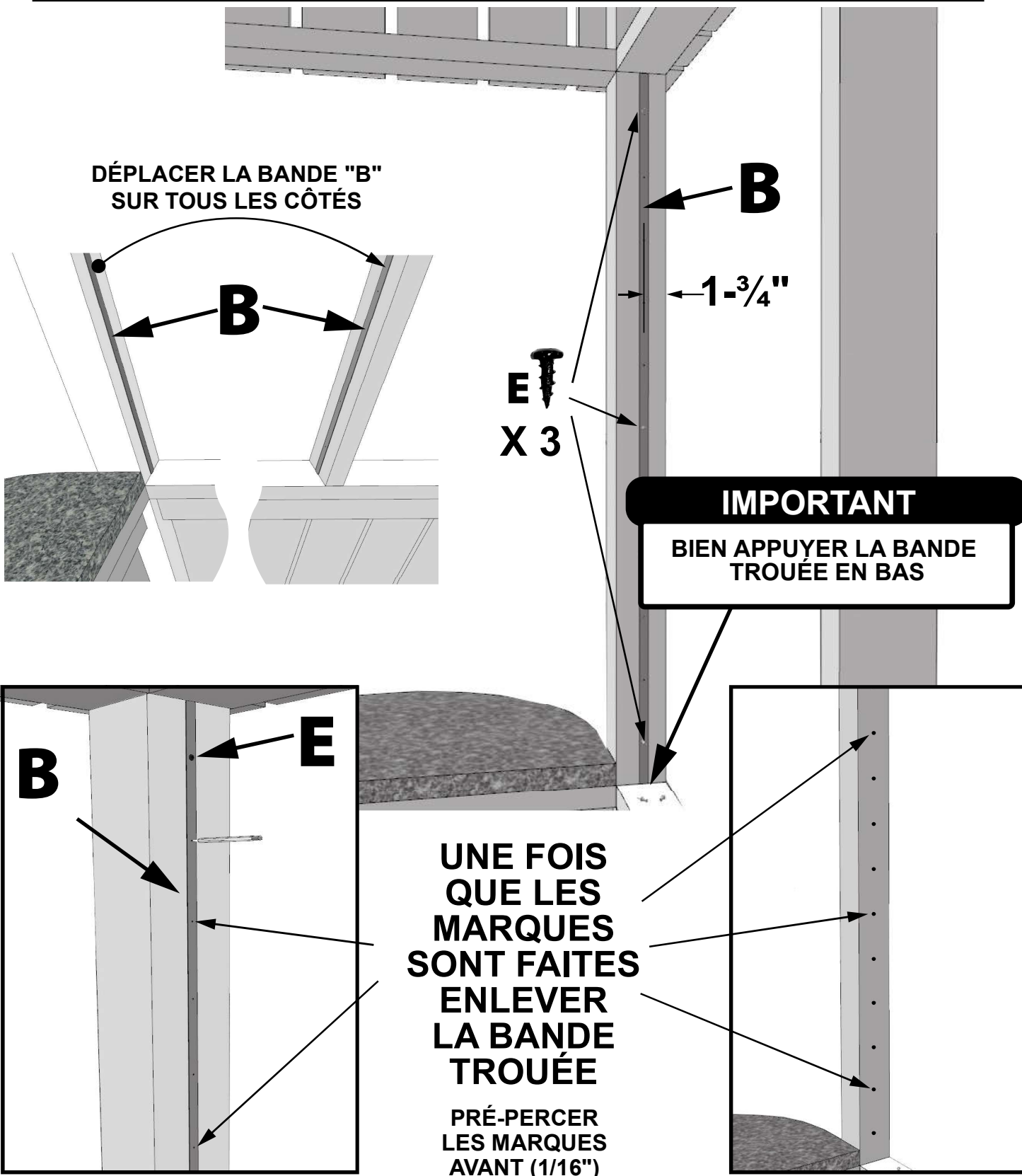

### ÉTAPE 3 - INSTALLATION DES PIÈCES "C" ET "D"

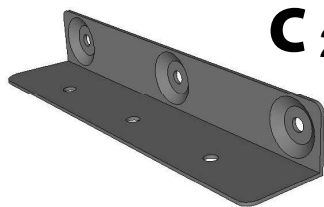

**C** 22X



**D** 22X



**F** 22X



**INSTALLER SUR  
CHAQUE MARQUE**

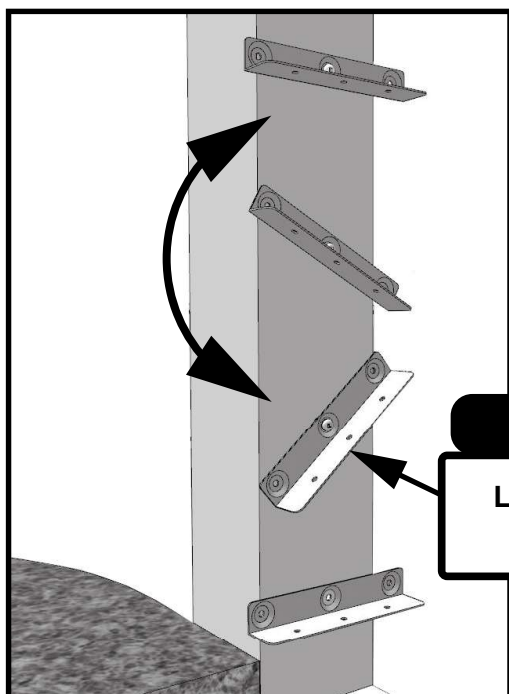
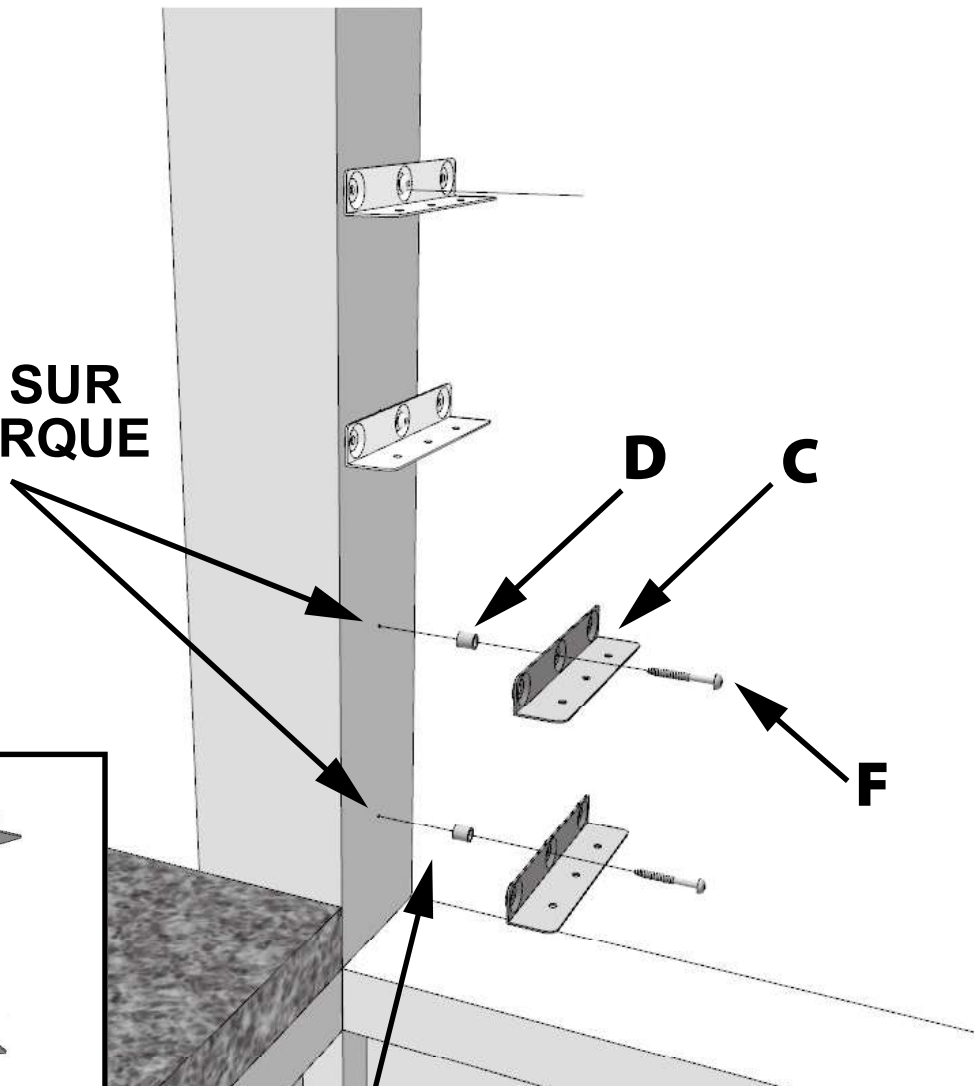

**IMPORTANT**

**LES SUPPORTS "C" DOIVENT  
PIVOTER LIBREMENT**

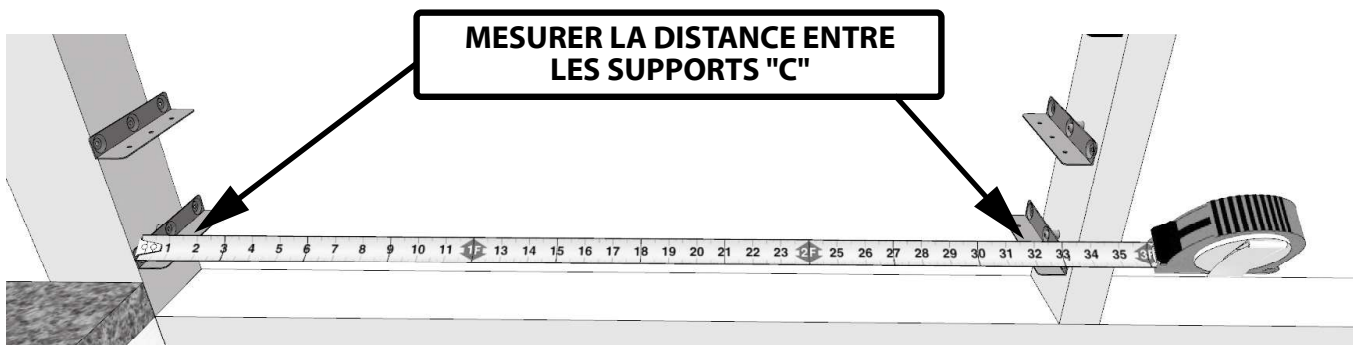
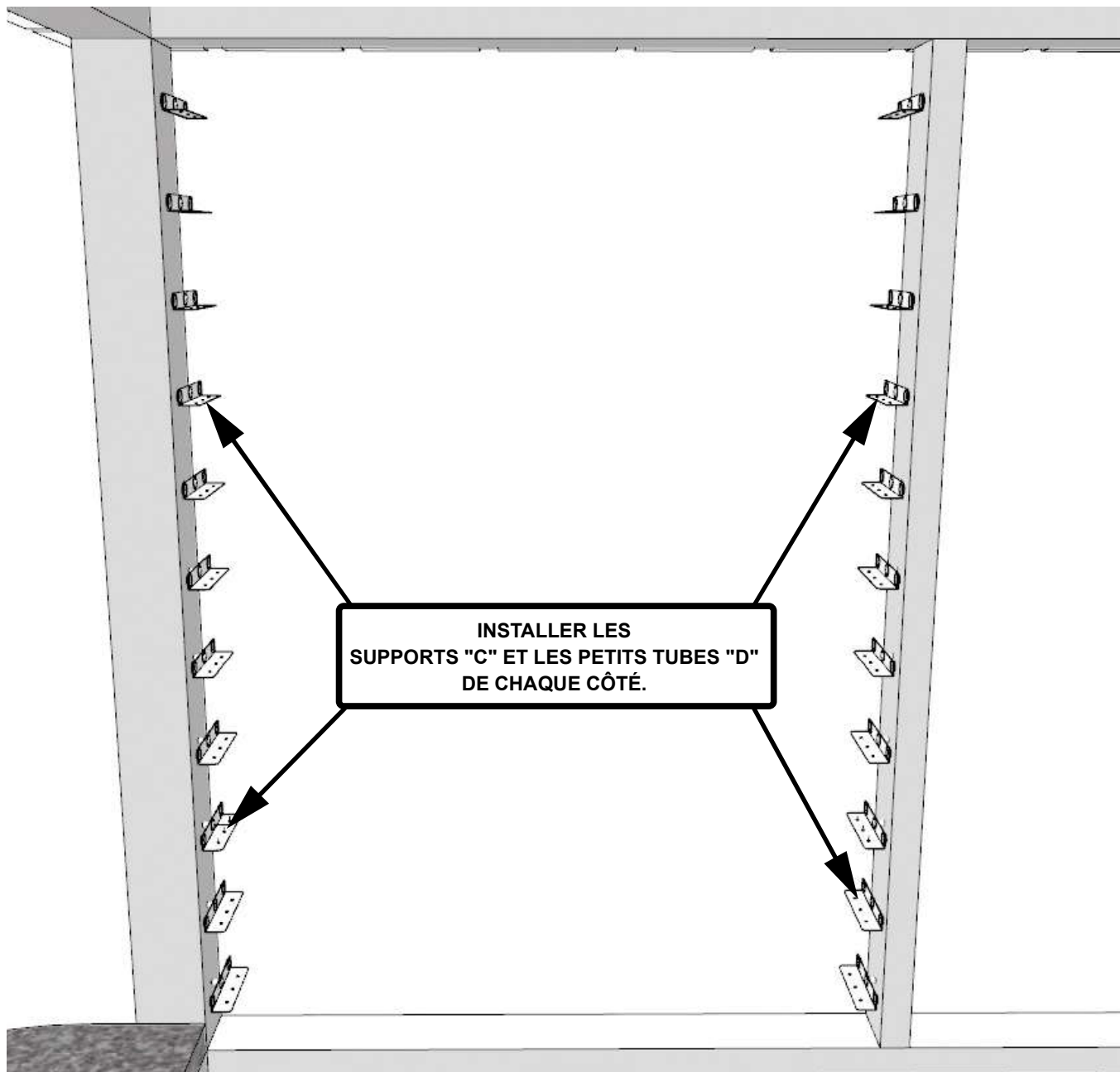

**(Répéter cette opération à chaque planche, il se peut que les planches ne soient pas toutes exactement de la même longueur)**

## ÉTAPE 4 - INSTALLATION DES PLANCHES

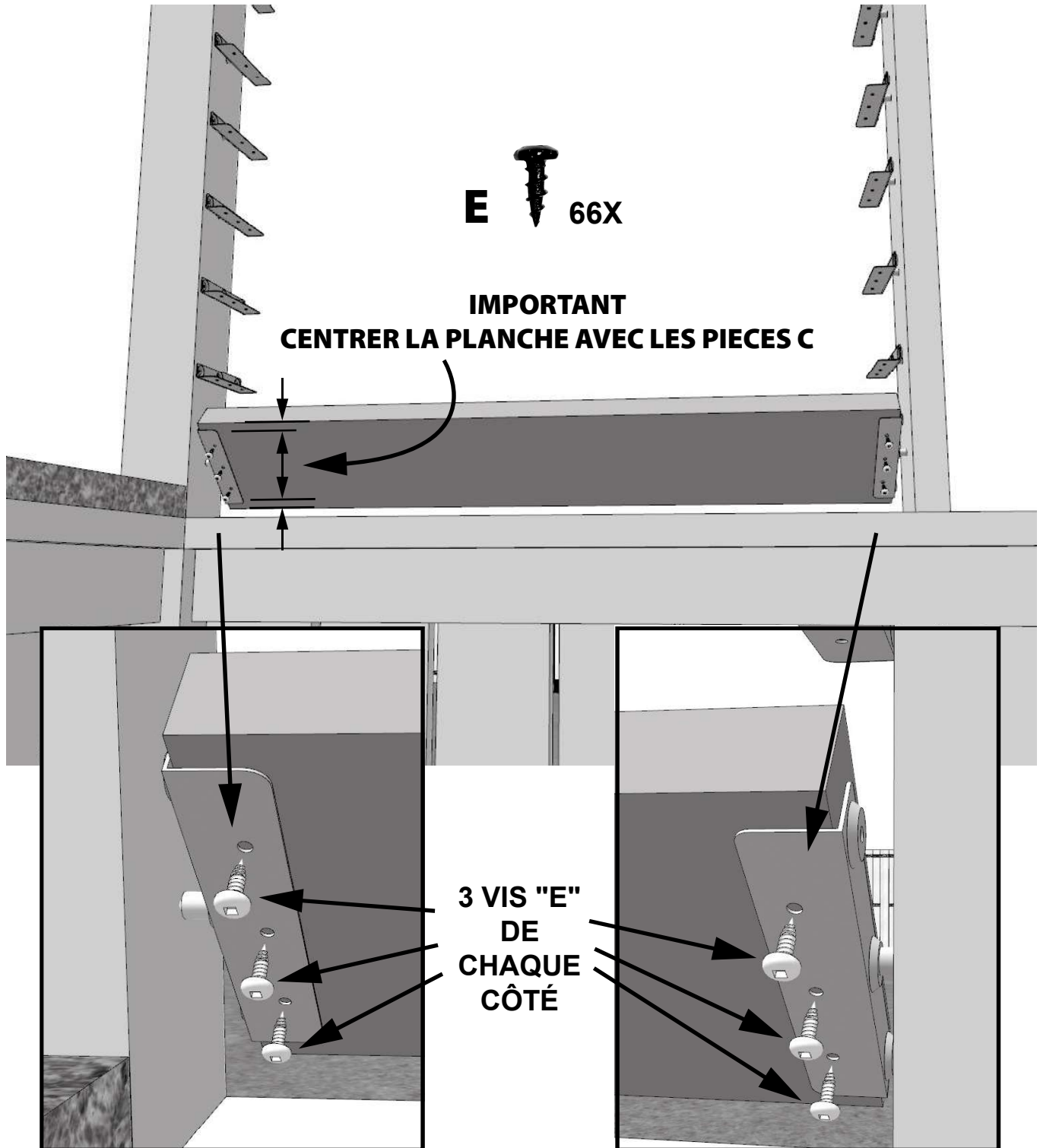

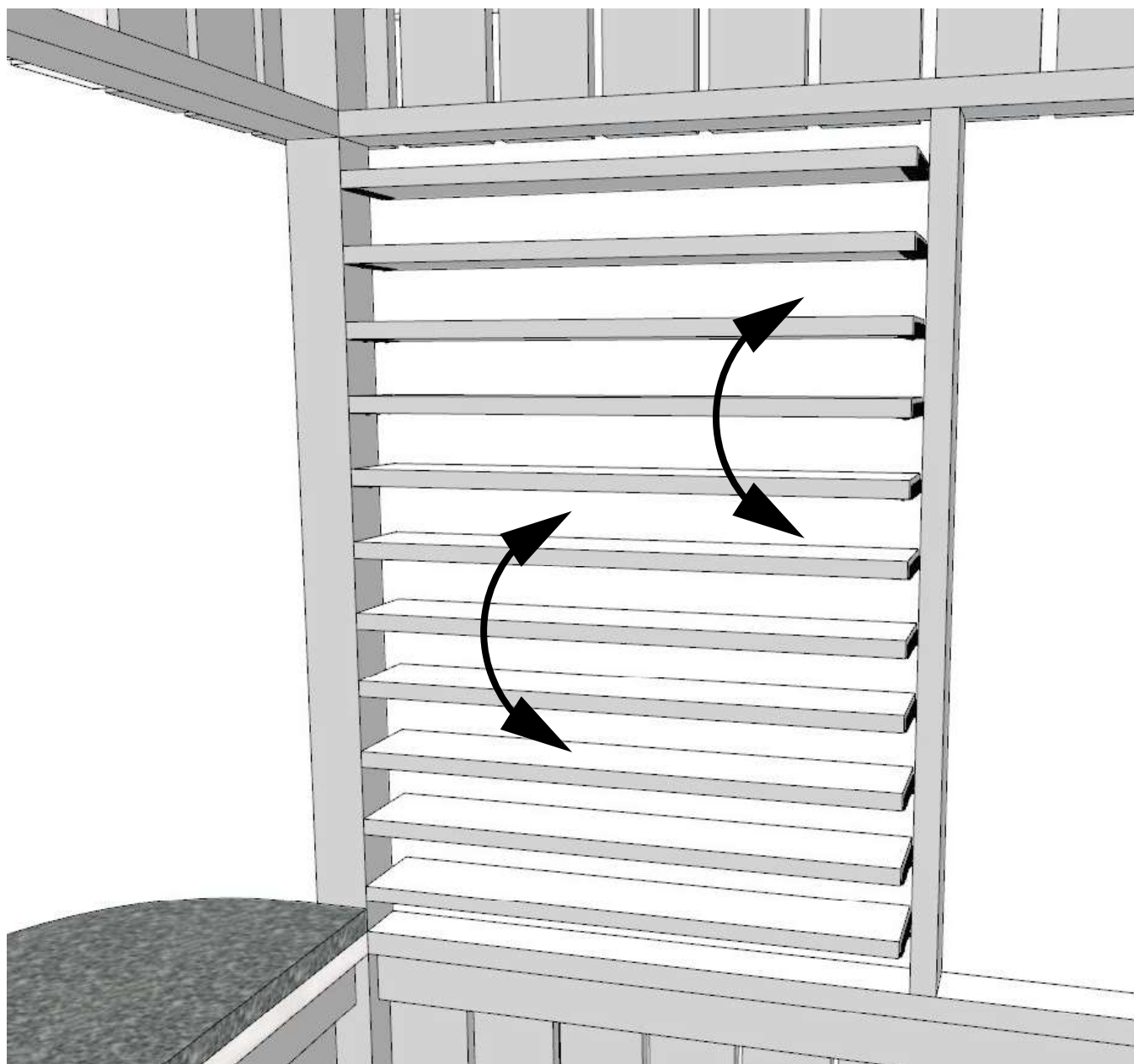

**IMPORTANT**

**LES PLANCHES DOIVENT  
PIVOTER LIBREMENT**



## ÉTAPE 5 - INSTALLATION DES PIÈCES "A"



**A** 10X

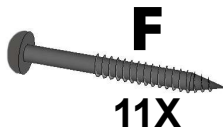

**F**  
11X



**IMPORTANT**

**LES PLANCHES DOIVENT  
PIVOTER LIBREMENT**

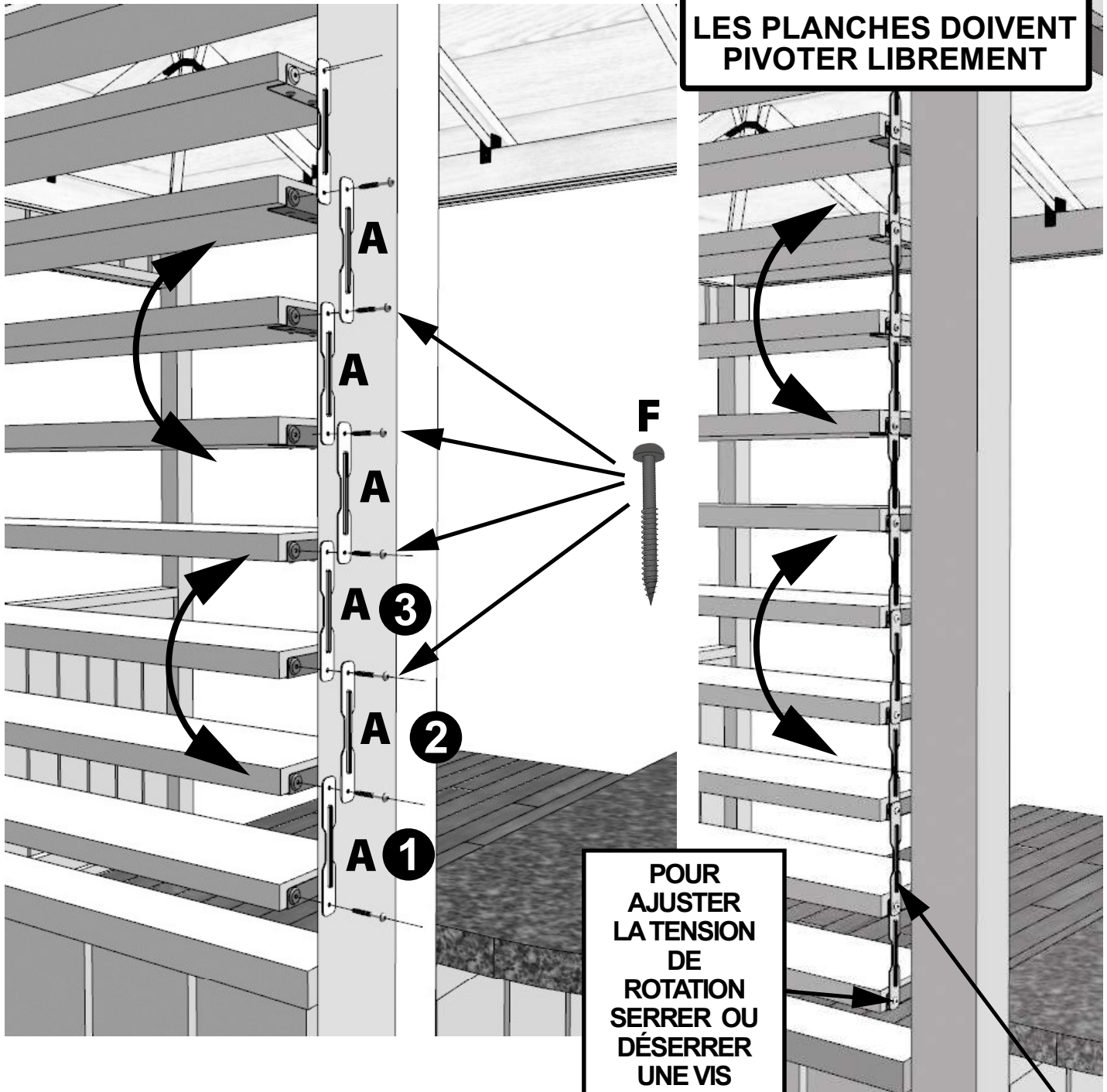

**POUR  
AJUSTER  
LA TENSION  
DE  
ROTATION  
SERRER OU  
DÉSERRER  
UNE VIS**

**LES PIÈCES "A" VONT SUR UN SEUL CÔTÉ**

## ÉTAPE 5 - INSTALLATION SUR UN 4" X 4" (EN COIN)

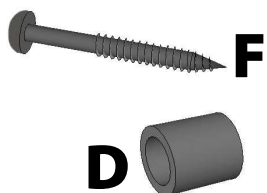
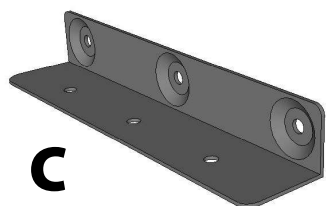

### POTEAU 4" X 4"

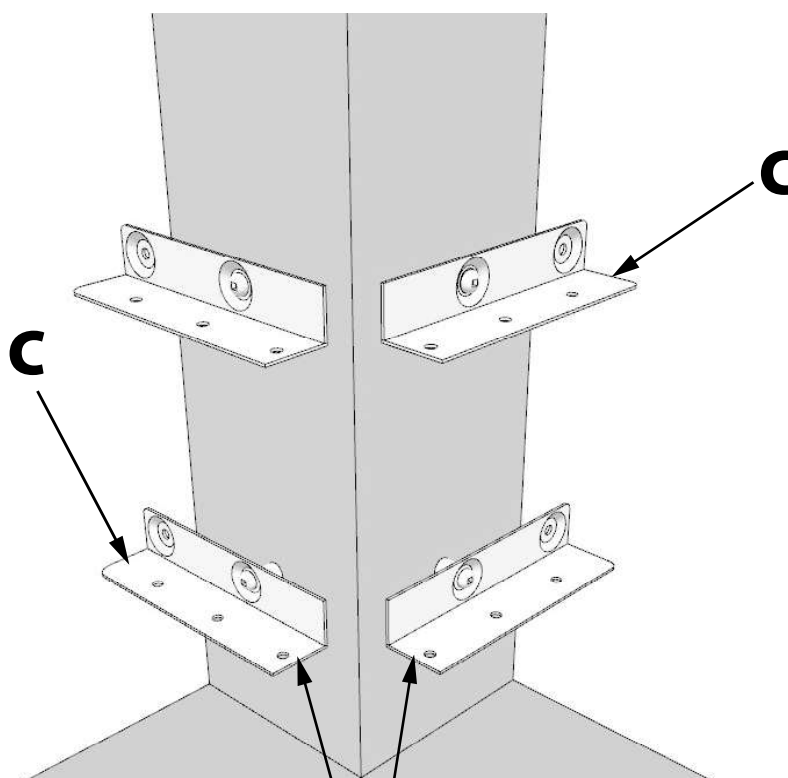

**COUPER LE COIN DES PLANCHES À 45°  
ET LES ÉQUERRES COMME ILLUSTRÉ**

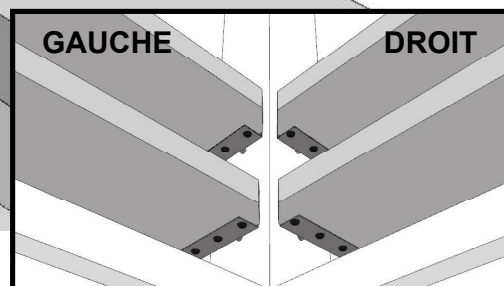
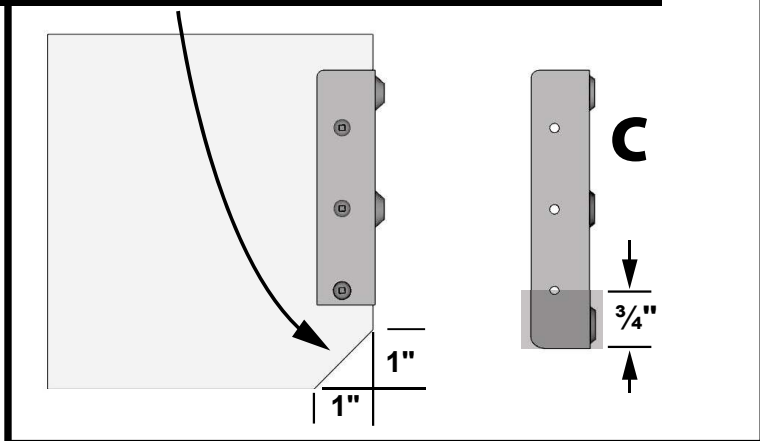

**COUPER LES  
ÉQUERRES DE MÉTAL DE 3/4"**

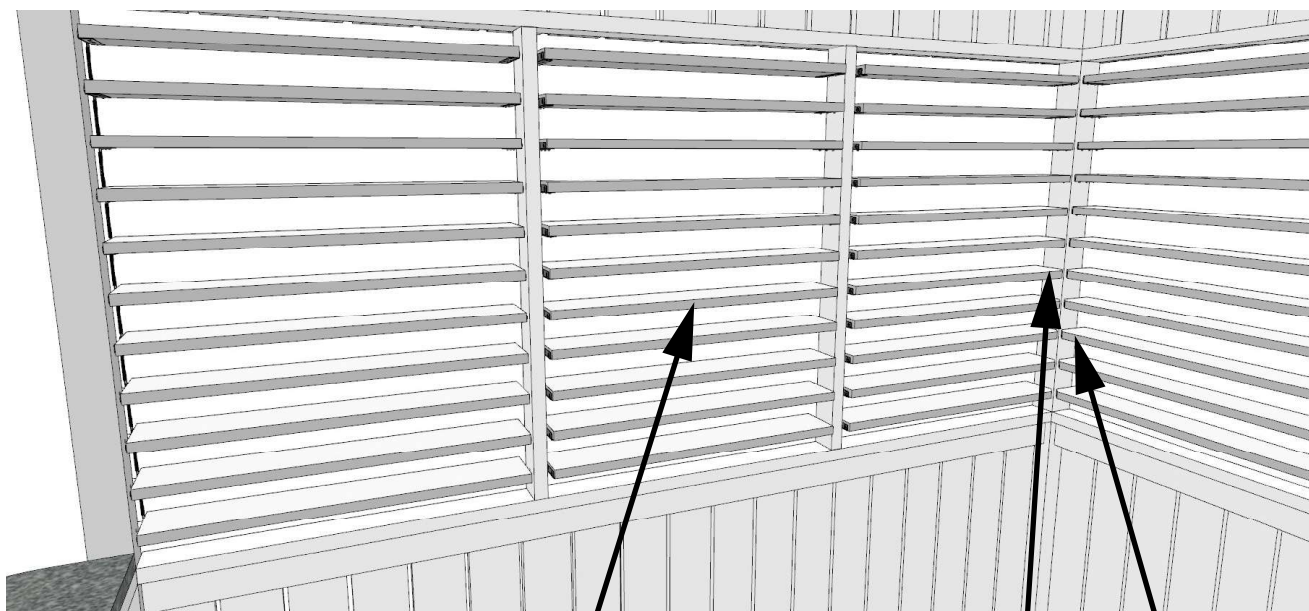

**INSTALLER LES AUTRES  
SECTIONS  
(Étape de 1 à 5)**

**COINS COUPÉS**

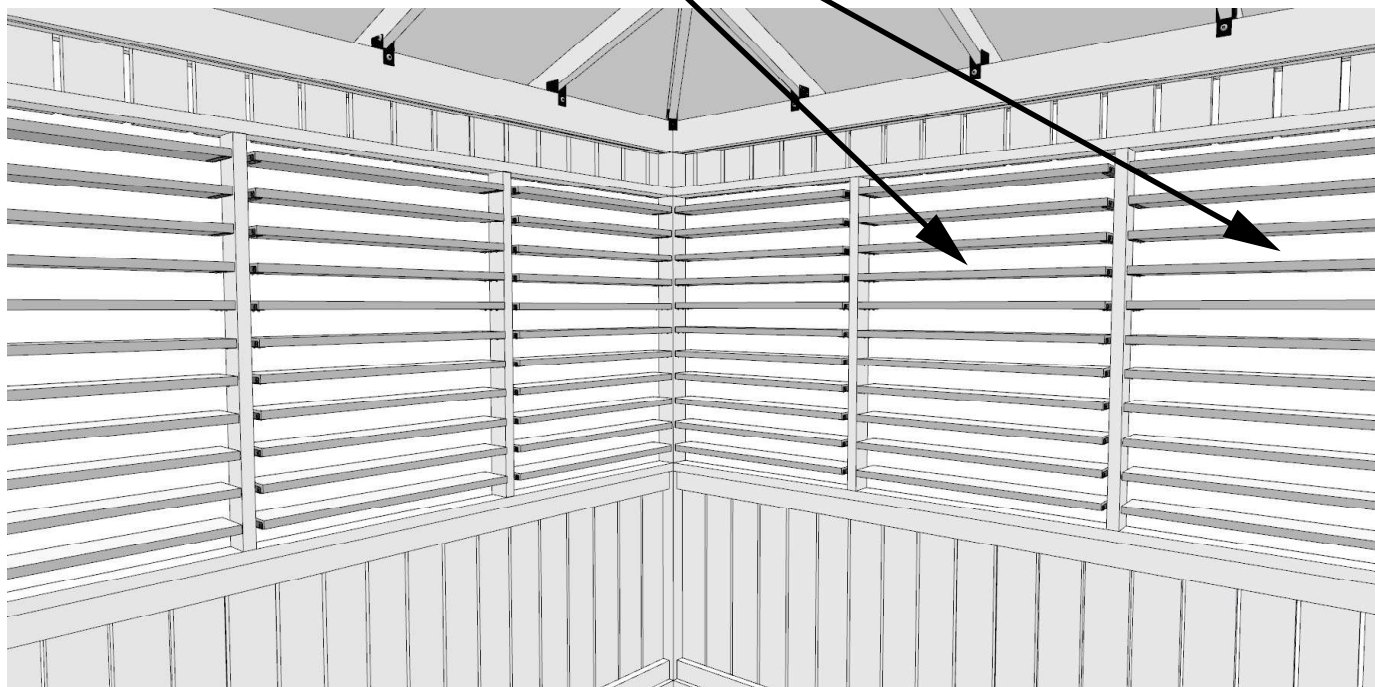

**ÉTAPE 1 - INSTALLATION SUR DES 6" X 6"**

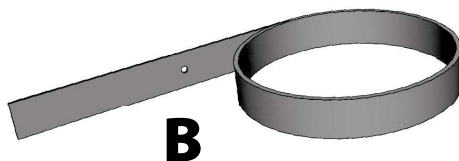

**POTEAU 6" X 6"**

**B**

**MARQUER  
CHAQUE TROU**

**2-3/4"**

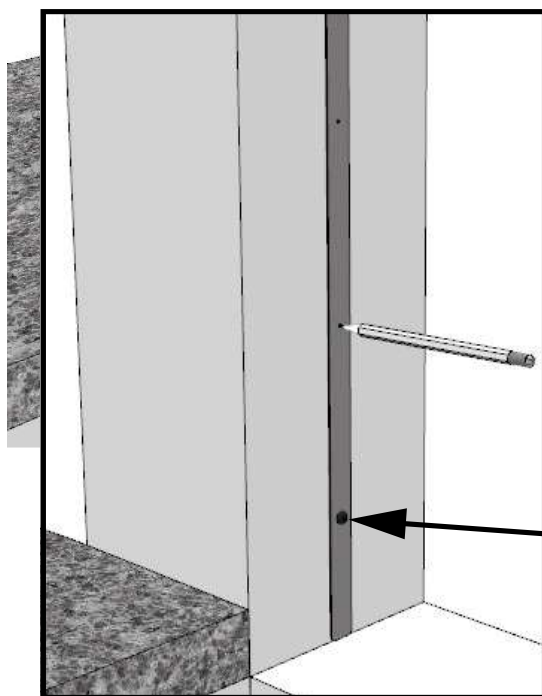

**E**  
**X 3**

## ÉTAPE 2 - INSTALLATION DES RIVETS

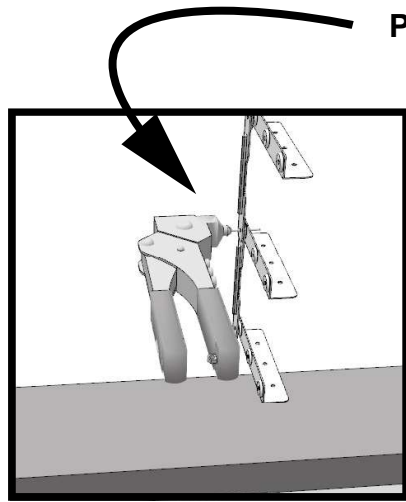
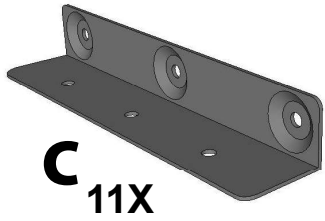

PISTOLET À RIVETS



VOUS ALLEZ  
AVOIR BESOIN  
DE RIVETS EN  
ACIER  
DE 1/8" X 1/4"  
(11 RIVETS - NON INCLUS)

ASSEMBLER TOUTES LES  
PIÈCES "A" ET "C"  
COMME ILLUSTRÉ  
AVEC LES RIVETS  
SUR UN SEUL CÔTÉ

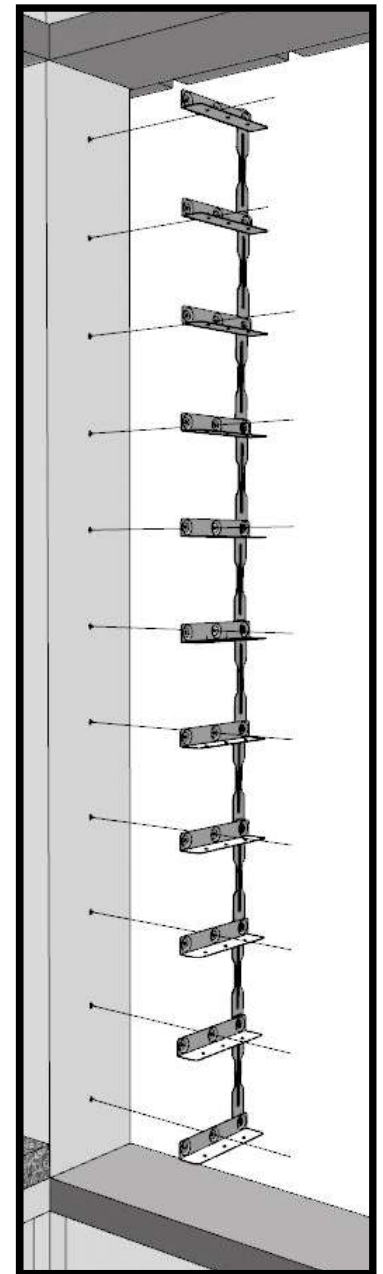
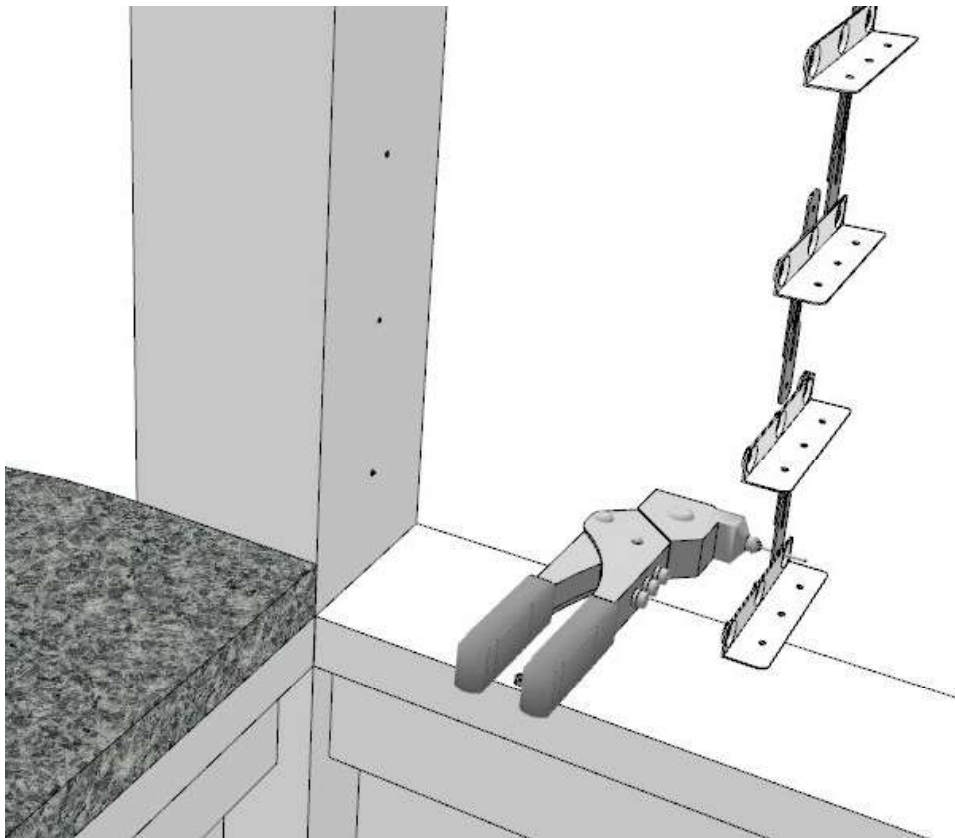

## ÉTAPE 3 - SUITE

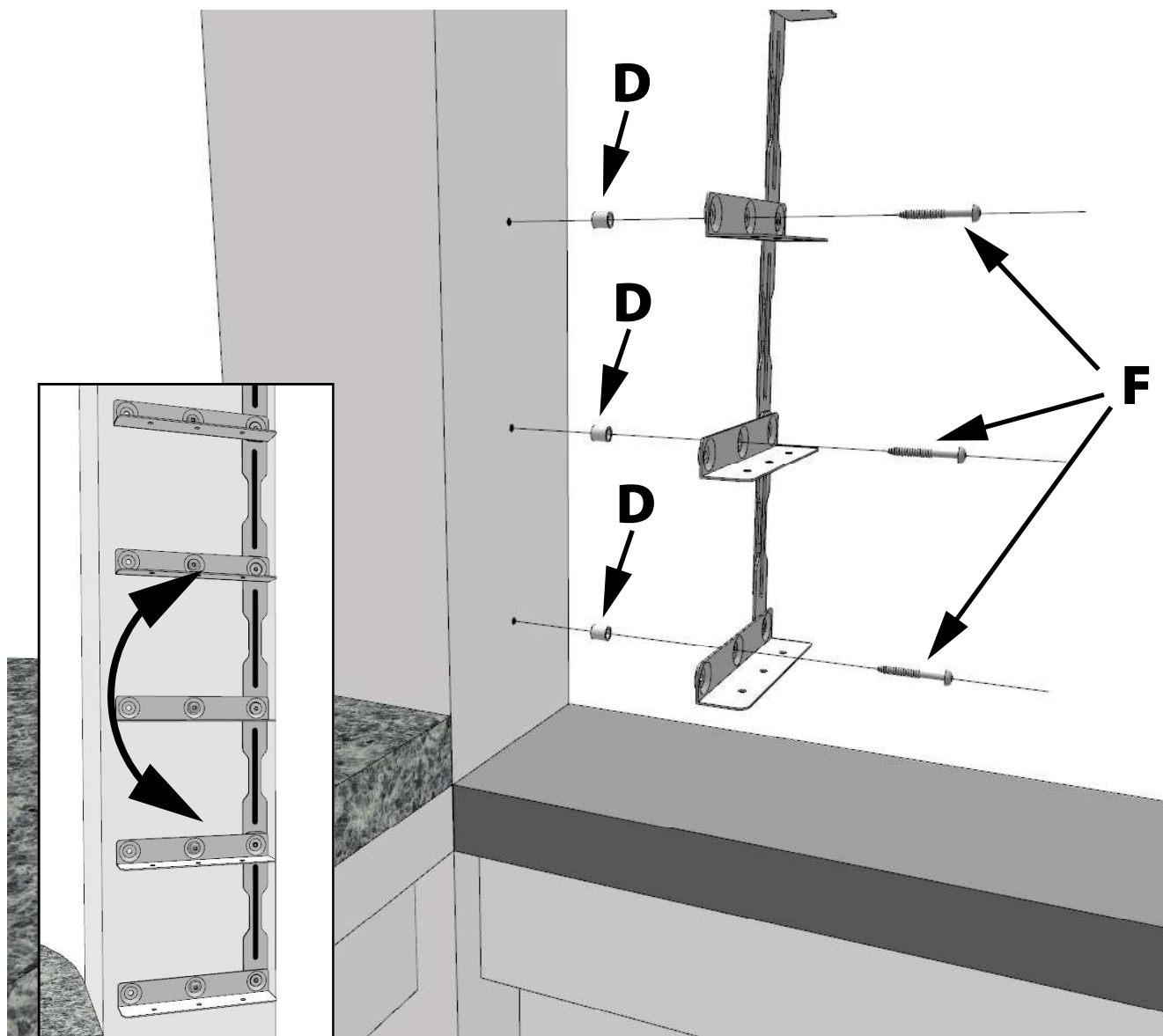

### IMPORTANT

LES SUPPORTS EN "C" DOIVENT  
PIVOTER LIBREMENT

# ÉTAPE 4 - INSTALLATION DES PLANCHES



**E**  **3 VIS "E"  
DE CHAQUE  
CÔTÉ**

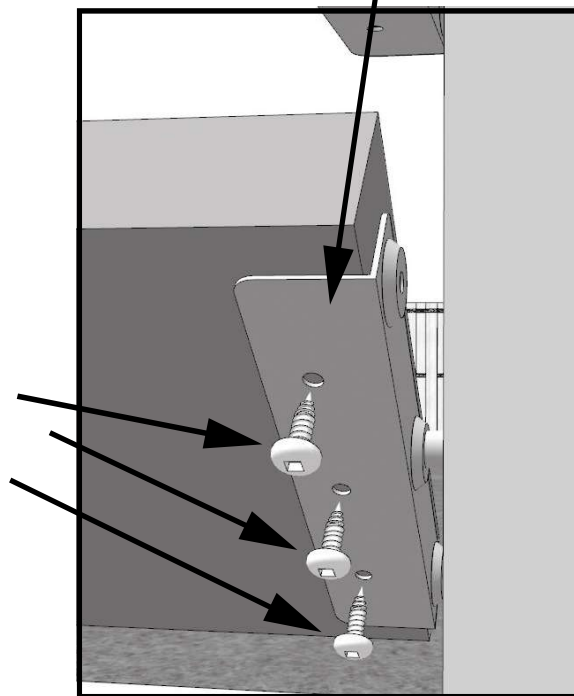
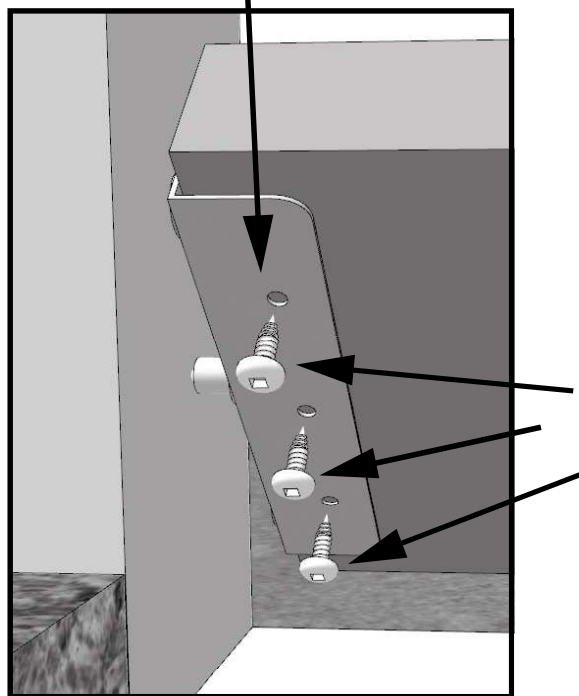
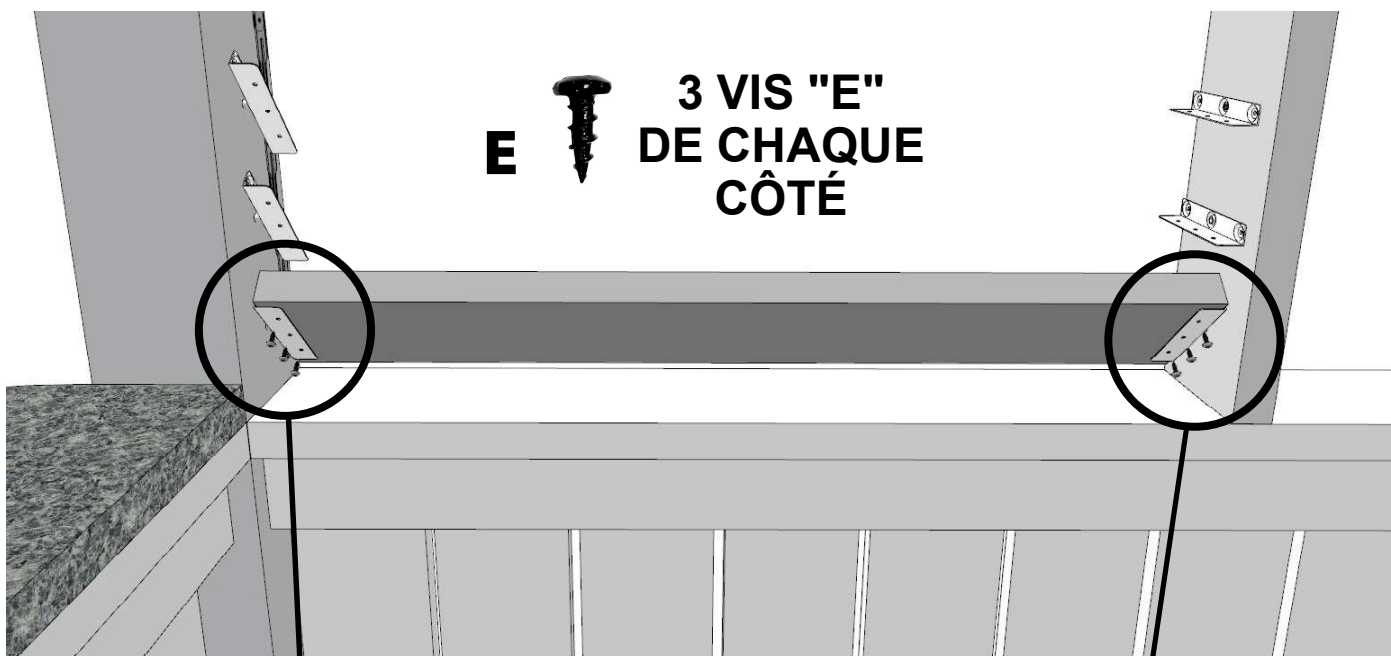

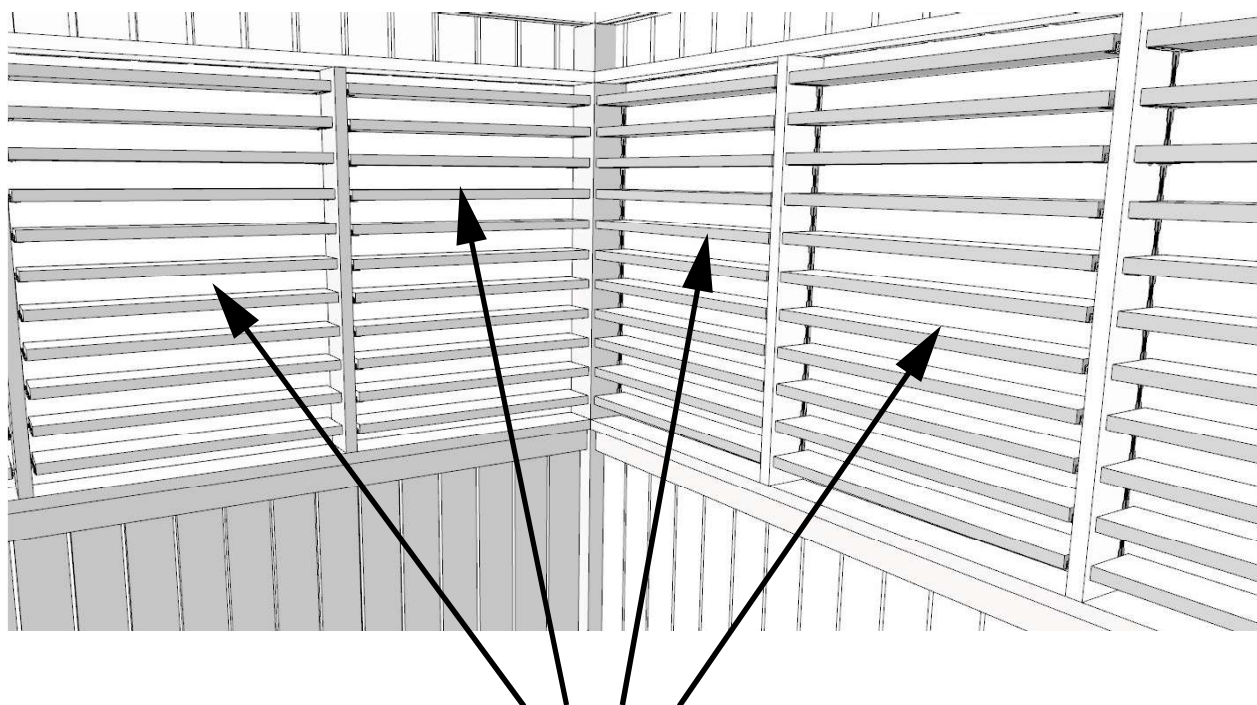

**INSTALLER LES AUTRES  
SECTIONS  
(Étape de 1 à 5)**

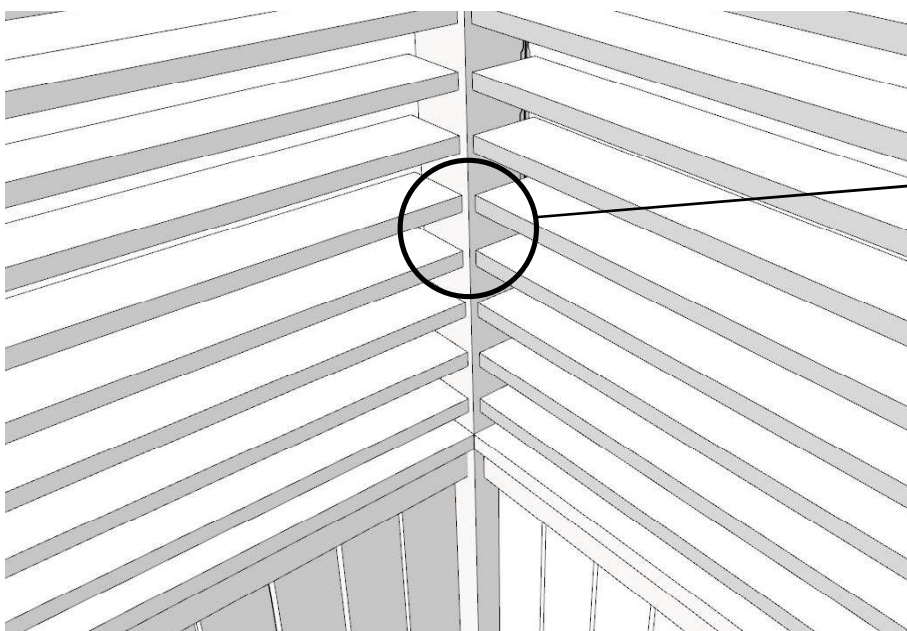

**NE PAS COUPER  
LES COINS  
AVEC UNE  
STRUCTURE  
DE POTEAUX  
6" X 6"**







**ÉVALUEZ NOUS!**



**Vous êtes satisfaits de votre produit Pylex?**

Faites-nous le savoir en nous envoyant des photos à [info@pylex.com](mailto:info@pylex.com)

Vous pouvez également écrire un avis en ligne sur votre achat.

*(En envoyant vos photos, vous autorisez Pylex à les utiliser dans son matériel marketing).*

*Merci !*

---

**VOUS AVEZ AIMÉ NOTRE PRODUIT ?**

Visitez notre site internet : [www.pylex.com](http://www.pylex.com) pour voir tous nos produits ou **scannez ce code QR** pour accéder à notre catalogue !



**Certificat de Garantie Pylex**



Suivez-nous sur :

